



INSTALLATION GUIDE

Warmboard Comfort System
Resistive electric

TABLE OF CONTENTS

Radiant panels	4
Tubing and manifolds	20
MEP: Natural gas, propane	32
Flooring	44
Commissioning	66
Water temperature chart	73



Notes with a blue bar: Tips to help save you time.

Notes with an orange bar: Tips to help save your hide.

GETTING STARTED

INSTALLATION REQUIREMENTS

1. The Warmboard Comfort System (WCS) **must** be installed by a licensed general contractor, heating professional, or plumber. Failure to use a properly licensed installer, failure to use the required parts and components, and/or any deviation from these installation guidelines may void related product warranties.
2. In order for WCS to operate correctly, tubing loops **must** be installed according to our documentation. **Do not** revise tubing loops or zones without first consulting Warmboard Inc.
3. WCS uses proprietary, plug-and-play controls including thermostats, manifold controllers, and a Smart Reset Controller. These items cannot be exchanged with alternative products.
4. **Do not** adjust any equipment settings without consulting Warmboard. Changes made through the SRC or the boiler's LCD screen can impact system performance and operation.
5. The use of a combustion analyzer is required to calibrate safe and effective combustion in natural gas and propane boilers. Failure to do so could result in injury or death (Lochinvar manual, Chapter 10: Start-up).

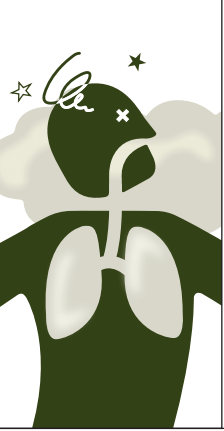
 WARNING 	
Breathing Hazard – Carbon Monoxide Gas	
	<ul style="list-style-type: none"> ▶ Do not operate heater if flood damaged. ▶ Install a vent system in accordance with local codes and manufacturers' instruction. ▶ Do not place chemical vapor emitting products near the unit. ▶ Per NFPA 720, carbon monoxide detectors should be installed outside each sleeping area. ▶ Never operate the heater unless it is vented to the outdoors. ▶ Analyze the entire vent system to make sure condensate will not become trapped in a section of vent pipe, thereby reducing the open cross sectional area of the vent.
Breathing carbon monoxide can cause brain damage or death. Always read and understand the instruction manuals.	

Follow all instructions and complete the Lochinvar and SpacePak registration cards.

Read these highlights before proceeding to save time, money and hassle.

Warmboard products are required to be installed and managed by experienced and licensed trade professionals pursuant to current local laws. Failure to use proper installers will void any product warranty.

Review this guide and the supplied working drawings (including the floor plan dimensions)

Do not revise tubing loops or zones without consulting Warmboard. Field changes will impact operation.

WCS PREPARATION

WCS is a unique offering that changes many aspects of a project which installers may be accustomed to. Control components, water temperatures, and network devices are all pre-configured and plug-and-play. Simply follow the instructions in this guide and the system will work.

ESSENTIAL DOCUMENTS

A general contractor is required to manage the job site and trade professionals involved. It is important to keep the Warmboard-supplied documents on site at all times as multiple contractors may need to reference them regularly. These documents include:

- 24" x 36" WCS Plan Set (provided with each shipment in the Panel Installation Kit)
- Equipment manuals (included with equipment)

The content below shows the most common sequencing of a WCS project. This guide is organized to follow these steps and ensure a successful installation of the Warmboard Comfort System.

WARMBOARD-S SEQUENCING

1. Pour foundation and roll joists.
2. Install Warmboard-S.
3. Frame walls.
4. Repeat previous steps for remaining levels.
5. Sheath exterior.
6. Head out manifold cabinet locations.
7. Install tubing, manifolds, and loop labels.
8. Install supply and return distribution lines for manifolds.
9. Rough-in electrical (e.g. boiler, thermostat, manifold controller...).
10. Rough-in mechanical (see equipment manuals).
11. Insulate and drywall.
12. Complete system electrical and plumbing.
13. Install Warmsource and other mechanical equipment.
14. Fill the system, commission Warmsource, and set flows.
15. Complete finish carpentry, finish floors, and paint.
16. Install thermostats and manifold controllers.
17. Connect system to local internet.

WARMBOARD-R SEQUENCING

1. Ensure the existing subfloor or slab is level, flat, and 100% dried in.
2. Install Warmboard-R.
3. Head out manifold cabinet locations.
4. Install tubing, manifolds, and loop labels.
5. Install supply and return distribution lines for manifolds.
6. Rough-in electrical (e.g. boiler, thermostat, manifold controller...).
7. Rough-in mechanical (see equipment manuals).
8. Insulate and drywall.
9. Complete system electrical and plumbing.
10. Install Warmsource and other mechanical equipment.
11. Fill the system, commission Warmsource, and set flows.
12. Complete finish carpentry, finish floors, and paint.
13. Install thermostats and manifold controllers.
14. Connect system to local internet.

RADIANT PANELS





CONTENT GUIDE

- ▶ Panel installation highlights Page 6
- ▶ Necessary tools Page 7
- ▶ Product description: Warmboard-S Page 8
- ▶ Product description: Warmboard-R Page 9
- ▶ Warmboard-S over joist Page 10
- ▶ Warmboard panels over subfloor Page 11
- ▶ Installing over slab: moisture testing Page 12
- ▶ Slab assemblies Page 14
- ▶ Fastening to slab Page 18

PANEL INSTALLATION HIGHLIGHTS⁶

1. Count the panels when they arrive on site and confirm the shipment is correct. Use the color code painted on the end of each panel to compare quantities against your plan set, which will be found inside your installation kit. If there are any questions or inconsistencies with your delivery, call us immediately.
2. Review the plan set to confirm floor plan dimensions and joist layout. Verify that both the joist direction and first joist locations are correct.
3. For Warmboard-S: Leave a 1/8" gap when butting panels together (the tongue-and-groove joints do not require any gapping).
4. For Warmboard-R: Gap 1/8" between panels on the 4' edge.
5. Use the alignment pins when fastening to ensure the tubing paths between panels line up.
6. When installing over floor joists, it is mandatory that the crawl space or basement have substantial ventilation, per IBC guidelines to outside ambient air (see "Exposure to Weather", pg. 10).
7. After installation, R-19 (or greater) insulation is required beneath the panels to prevent downward heat loss.

Warmboard-R panels **cannot** be exposed to water or excess moisture. Exposure will void any product warranty.

After installation, should Warmboard-S be exposed to rain, **do not** install subfloor insulation until the panels have returned to an acceptable level of moisture content.

NECESSARY TOOLS

INSTALLATION KIT CONTENT

(Supplied with order)

- ▶ Warmboard® panel/tubing plans
- ▶ 3 Custom routing templates (wood)
- ▶ 2 Alignment pins
- ▶ 5/8" Router bit
- ▶ Router template guide
- ▶ Router guide lock nut
- ▶ Tubing cutter

OTHER TOOLS AND MATERIALS

- ▶ Circular saw, carbide blade
- ▶ Router, minimum 2 horsepower (pg. 24)
- ▶ 16oz Rubber mallet
- ▶ Shop vacuum
- ▶ Drill with 3/4" drill bit
- ▶ Wax pencil or permanent marker
- ▶ Tubing un-coiler
- ▶ 4" Grinder

PRODUCT DESCRIPTION: WARMBOARD-S™

Warmboard-S™ is a tongue-and-groove hydronic radiant subfloor panel designed to seamlessly integrate radiant heating into a building's structure. Warmboard-S is typically installed over joists (24" OC maximum), but application over sleepers, existing subfloors, and concrete slabs is also common.

Made from 7-ply Douglas Fir plywood, panels measure 4'x8', are 1^{1/8}" thick, and weigh approximately 100 lbs. In a completed assembly, Warmboard-S weighs 3 lbs per sqft, including the panel, tubing, and water.

Warmboard-S consists of four modular panel types. Though routed differently, each panel type shares the same design features for easy installation. The panels have precisely sized tubing channels that securely hold 1/2" PEX or PEX-AL-PEX tubing. To enhance heat transfer from the tubing to the floor, the top surface of Warmboard-S, including the channels, is bonded to a conductive 0.025" layer of 1070 aluminum alloy.

Non-aluminum filler panels are also available.

L LEFT TURN PANEL

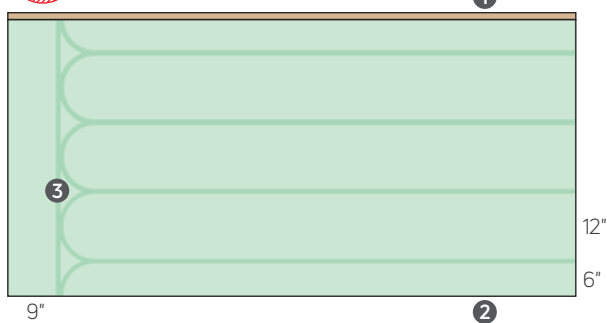

R RIGHT TURN PANEL

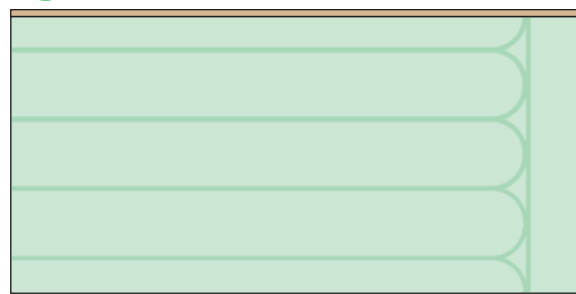

S STRAIGHT PANEL

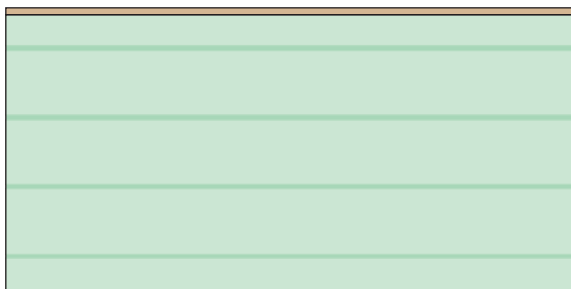

D DOUBLE PANEL

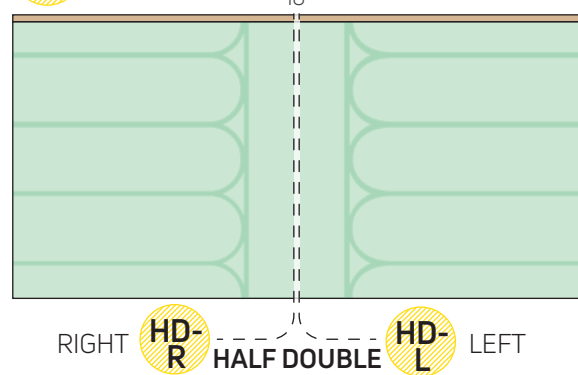

- ① Tongue side of panel
- ② Groove side of panel
- ③ Tangential PEX groove

APA Report T2002Q-37 // ICC Report ESR-1421

If only installing Warmboard radiant panels (and not the Warmboard Comfort System), note that Warmboard-S panels are but one component in a complete radiant system. System design is the responsibility of the system designer and should be done in accordance with manufacturers' recommendations for ancillary components.

PRODUCT DESCRIPTION: WARMBOARD-R™

Warmboard-R™ is a hydronic radiant panel designed to integrate radiant heat into the flooring underlayment of a building. Panels are typically installed over existing subfloors or concrete slabs. Wall and ceiling applications are also possible when needed.

Made from high-quality oriented strand board (OSB), Warmboard-R measures 23^{7/8}" x 48", are 13/16" thick and weigh approximately 25 lbs. In a completed assembly, Warmboard-R weighs 3 lbs. per sqft, including the panel, tubing, and water.

Warmboard-R consists of two modular panel types. Though routed differently, both panels feature the same design details which make them effective and simple to install. Tubing channels, which are precisely sized to securely retain 1/2" PEX or PEX-AL-PEX tubing, are routed into the surface of the panels. To enhance heat transfer from the tubing to the floor, the entire top surface of Warmboard-R, including channels, is bonded to a conductive 0.025" thick skin of 1070 aluminum alloy.

Non-aluminum filler panels are also available.

RT TURN PANEL

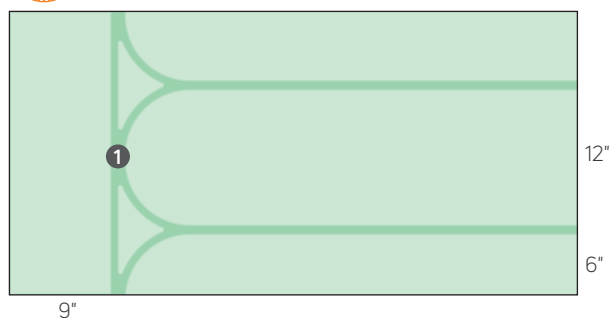

RS STRAIGHT PANEL

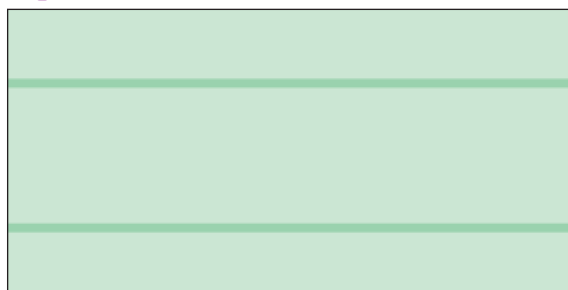

Warmboard-R panels **cannot** be exposed to water or excess moisture. Exposure will void any product warranty.

If only installing Warmboard radiant panels (and not the Warmboard Comfort System), note that Warmboard-R panels are but one component in a complete radiant system. System design is the responsibility of the system designer and should be done in accordance with manufacturers' recommendations for ancillary components.

WARMBOARD-S OVER JOIST

For a joist application, Warmboard-S panels install like any other tongue and groove subfloor. Follow applicable building codes and industry practices for the sizing of fasteners and selection of subfloor adhesive. The use of screws or ring shank nails does not negate the benefits of using subfloor adhesive.

Unless a more frequent nailing schedule is specified by a structural engineer, the American Panel Association (APA) specifies a maximum spacing of 6" at panel edges and 12" at intermediate supports.

Warmboard-S panels can be trimmed to length or ripped with a circular saw or table saw, similar to other sheet goods.

Use the alignment pins supplied in the panel install kit when placing each panel. Tap the alignment pins into the two outer most channels, across the seam between the adjacent panels, to ensure channel alignment. Follow the Panel Layout in the plan set as the work proceeds.

All subfloor panels, including Warmboard-S, should be gapped 1/8" at butt joints in the subfloor.

EXPOSURE TO WEATHER

Warmboard-S panels are rated by the APA as "Exposure 1", meaning they can be exposed to occasional and intermittent rain, snow, and ice for a building season and still serve as structural subfloor. Warmboard-S panels will still respond to moisture like any plywood product, which means minor edge swelling can occur from water intrusion.

Should panels experience water intrusion, create a dry and well-ventilated environment beneath the subfloor to release this moisture from the underside of the panels. Water will not exit through the top surface due to the full skin of aluminum.

Do not insulate below the panels until the structure is completely dried-in and all excess moisture has been released from the panels.

The tips below are crucial to understand and follow:

- Keep the panels completely dry and covered until the time of installation.
- If installing over a crawl space or basement, this area **must** be well-ventilated (per IBC guidelines) and completely dry throughout the construction process.
- Warmboard-S panels **must not** be exposed to prolonged moisture. Work to keep the panels as dry as possible before, during, and after installation.
- If edge swelling occurs, the panels will return close to their original shape once the moisture exits the panels.

It is **essential** to check your plan set (inside the installation kit) to see where the first panel is to be installed.

When using a circular saw, cut panels with the aluminum side down. Save offcuts as they may be used elsewhere.

If Warmboard-S is exposed to rain or snow, create a constantly dry and well-ventilated environment so the moisture can be released from the bottom of the panel.



WARMBOARD PANELS OVER SUBFLOOR

PREPARATION

It is essential that the existing subfloor is both flat and smooth before the installation of any Warmboard panels. Similar to the NWFA guidelines, the subfloor should be flat within 1/8" per 6 feet.

Inspect the subfloor for evenness along the joists and flatness between the joists. If necessary, sand the subfloor and install necessary blocking below. Inspect for squeaks and refasten as needed.

Warmboard panels can be trimmed to length or ripped with a circular saw or table saw, similar to other sheet goods.

Follow the Panel Layout in the plan set when selecting which panels to place, then align those panels using the alignment pins supplied in the install kit. Fasten each panel before moving onto the next.

FASTENING SCHEDULE

Warmboard-R: Place fasteners 12" OC on both the edges and field of the panels. Fasten with a pattern of 3 rows of 4.

Warmboard-S: Place fasteners 6" OC at edges of the panels and 12" OC across the field of the panels.

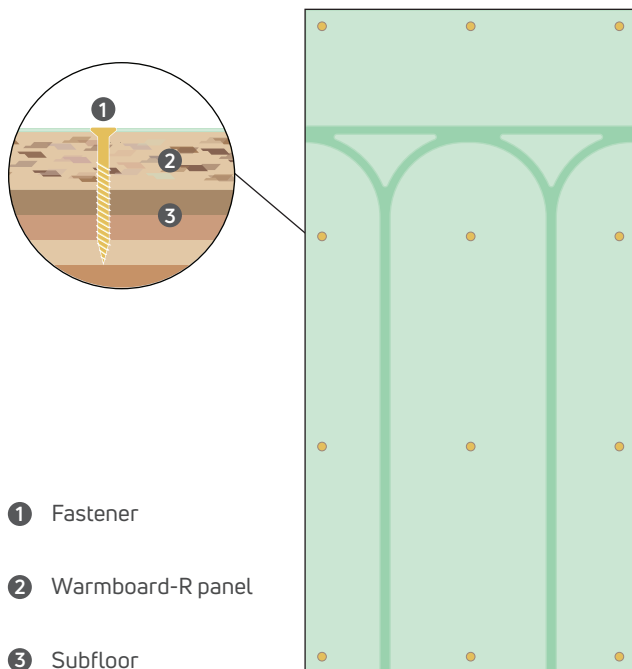

METHOD 1: SCREW ONLY

Select a #8 (or greater) self-tapping screw approved for decking and framing applications. For ease, select a screw with a countersinking head and a smooth shank. Screws should be sized so that they grab the entire thickness of the subfloor beneath the panel.

Maintain the proper fastening schedule while fastening the panels to the subfloor.

METHOD 2: NAIL AND GLUE

Select an 8d (or greater) ring shank nail or screw nail. Nails should be sized so they grab the entire thickness of the subfloor beneath the panel when fully driven.

Use a construction adhesive designed for a subfloor application. Follow all directions specified by the adhesive manufacturer and maintain the proper fastening schedule while fastening the panels to the subfloor.

METHOD 3: SLEEPERS (-S PANEL ONLY)

Install sleepers parallel to each other in the desired orientation at a maximum spacing of 24" OC.

Insulate between the sleepers ensuring that the cavity is filled with applicable insulation material.

Follow the installation instructions for Warmboard-S over joists on the previous page. Before installing over sleepers, ensure the Warmboard-S panels and subfloor are completely dry as excess moisture cannot escape through the aluminum surface of the panels.

It is crucial to use the alignment pins to line up the channels from panel to panel.

The subfloor and Warmboard panels **must** be completely dry, with a moisture reading between 8-12% before, during and after installation.

Extra fasteners around the tangential groove of turn panels may be advantageous.

INSTALLING OVER SLAB: MOISTURE TESTING

CONCRETE SLAB REQUIREMENTS

Whether a remodel or new construction, slabs **must** be flat and smooth before any panel installation steps can be taken. Where slabs do not meet this criteria, take the necessary steps to produce a flat and smooth surface.

Once determined to be flat and smooth, the slab should be checked for moisture.

If the slab is severely unlevel, consider forgoing a leveling product and instead choose the sleeper installation method noted in this guide. Scribe and cut the sleepers to create a level plane for the Warmboard-S installation.

Similar to the NWFA guidelines, the slab should be flat within 1/8" per 6 feet.

MOISTURE TESTING

Like any wood product, if Warmboard panels are exposed to standing water or moisture intrusion, the panel can swell and rot. **Do not** install Warmboard panels if these environmental conditions are possible during or after construction.

It is best practice to test both new and existing slabs for moisture. A newly poured slab must cure for a minimum of 30 days before a moisture test should be conducted. As the slab dries, periodic tests will likely be necessary before the slab is dry enough for the vapor retarder and Warmboard panels to be applied.

The following tests are useful in determining current slab conditions, though some tests are more relevant than others. The outcomes of these moisture tests can be affected by the weather conditions on the job site. Generally, these tests will want to be completed in mild weather such as 75° (+/- 10°F) and 50% (+/- 10%) relative humidity, but always verify with the selected testing procedures.

If not performing a moisture test, we recommend giving a new slab at least 90 days to cure before moving forward with the installation in conjunction with the use of a Class I vapor retarder.

ASTM F1869-22: CALCIUM CHLORIDE



This test determines the moisture vapor emission rate (MVER) from a concrete slab. It produces quantitative results which represent how much water vapor is leaving the slab at the time of the test.

This test is simple, inexpensive, and readily available for purchase through online retailers. Instructions are provided in the test kit and can be found in documentation provided by the ASTM.

The test should be conducted three times in the first 1,000 sqft of concrete slab, then tested once every 1,000 sqft after that. Compare the test results to the requirements/specifications of the selected vapor retarder as well as the finish flooring to be installed above the Warmboard panels.

Generally, an acceptable test result will be: < 3 lbs/1,000 sqft/24 hrs.

ASTM F2170-19A: RELATIVE HUMIDITY PROBE



Relative humidity moisture tests using in-situ probes return quantitative values for the moisture content within the core of a concrete slab. The in-situ probe measures the relative humidity of the slab at 40% of the slabs depth (20% for suspended slabs).

This test is more expensive in comparison to the Calcium Chloride test, but provides a more thorough evaluation of the slab condition. Instructions are provided in the test kit and can be found in documentation provided by the ASTM.

This test should be conducted three times in the first 1,000 sqft of concrete slab, then tested once every 1,000 sqft after that. Compare results to the requirements/specifications of the selected vapor retarder as well as the finish flooring to be installed above the Warmboard panels.

Generally, an acceptable test result will be: <80%

ASTM F2659-23: ELECTRONIC MOISTURE METER



Non-destructive electronic moisture meters are an effective way to evaluate the surface conditions of a concrete slab. Use this process to determine testing locations for ASTM F1869-22 and ASTM F2170-19A test methods.

As the test measures only surface conditions, it will not offer a reliable insight to slab conditions. Instructions for this test can be found in documentation provided by the ASTM.

This test should be conducted three times in the first 1,000 sqft of concrete slab, then tested once every 1,000 sqft after that. One test consists of three to five readings within a 1 sqft area at each location.

ASTM D4263-83: PLASTIC SHEET METHOD

While this test indicates the presence of capillary moisture in a slab, it offers little information on the extent of potential moisture issues.

To begin, place an 18" x 18" clear plastic sheet on the slab and tape down on all sides. Do this once per every 500 sqft of the slab. **Do not** allow the sheet to come in contact with direct sunlight or excessive heat.

After 16 hours, remove the plastic and examine both the sheet and concrete for signs of moisture. If there is condensation on the sheet or the concrete appears darkened, moisture is present in the slab.

This method may yield a false result in cool conditions should the concrete retain moisture and fail to condense on the plastic.

SLAB ASSEMBLIES

VAPOR RETARDERS ABOVE SLABS

Regardless of whether or not moisture tests were successful or an underslab vapor retarder is present, Warmboard **always** recommends applying a Class I vapor retarder above a concrete slab before installing Warmboard panels.

Since the conditions of slabs can change over time (for better or worse), it is best practice to protect against possible moisture intrusion in the slab.

As defined by the The ICC, a Class I vapor retarder has a permeability rating of < 0.1 perms. Various liquid vapor retarders, as well 6- or 10-mil poly sheeting, meet this specification. The Technical Data Sheet (TDS) for a vapor retarder will generally note its permeability rating.

Vapor retarders have their own specific installation requirements. Ensure slab conditions meet the requirements from the vapor retarder's TDS. Apply the selected vapor retarder before moving on with the rest of Warmboard panel assembly. If using poly sheeting, overlap the seams 24" between sheets.

RECOMMENDED: DIRECT FASTEN, WARMBOARD-R

For slab applications, the basic assembly method is to fasten Warmboard-R directly to the slab. This method is best when there is existing insulation beneath the slab.

After installing the selected vapor retarder, continue with the Warmboard-R installation using split drive anchors, powder actuated fasteners, or concrete screws (pg. 18)

Use a minimum of 9 fasteners per full panel, using a pattern of 3 rows of 3.

The slab **must** have sufficient drainage from rain and snow at all times. Failure to provide sufficient drainage will void any product warranty.

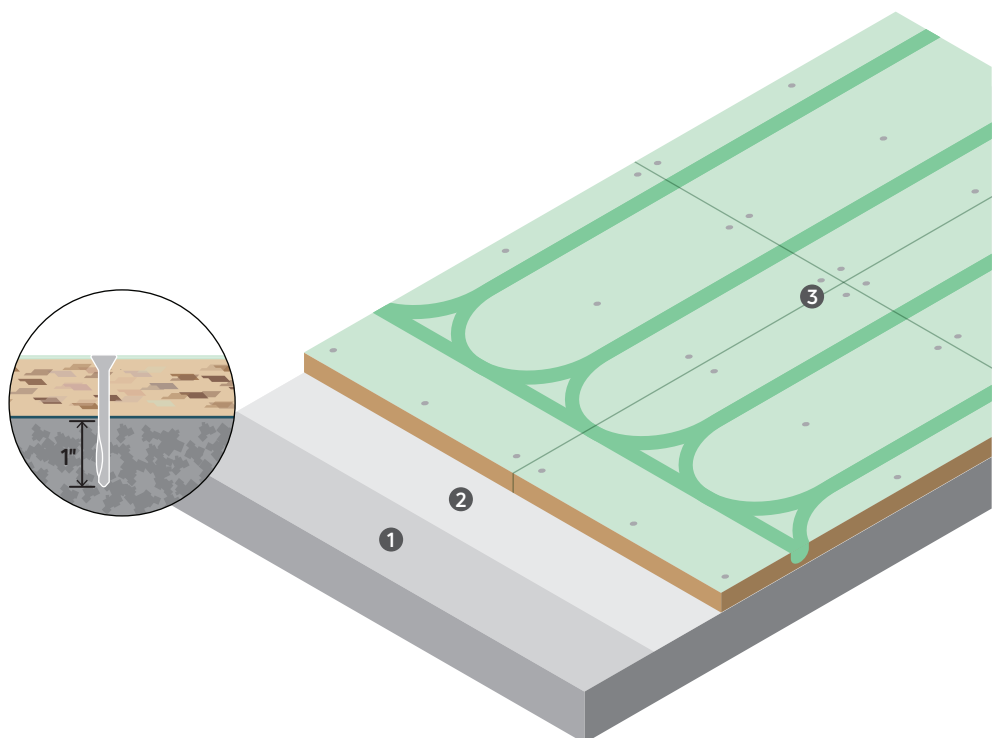

- ① Concrete/slab
- ② Vapor barrier
- ③ Warmboard-R panel

RECOMMENDED: INSULATED, WARMBOARD-S ON SLEEPERS

When needing to insulate above a slab, installing Warmboard-S on sleepers is a cost-effective method.

Once a vapor retarder is applied, install sleepers per plan at a maximum spacing of 24" on center. Insulate between the sleepers, ensuring the entire cavity is filled with applicable insulation material.

Follow the installation instructions for Warmboard-S over joists. Ensure Warmboard-S is dry before installing as excess moisture cannot escape through the aluminum surface of the panels.

The slab **must** have sufficient drainage from rain and snow at all times. Failure to provide sufficient drainage will void any product warranty.

- 1 Concrete/slab
- 2 Vapor barrier
- 3 Pressure treated sleeper (16 or 24" oc)
- 4 Rigid foam insulation
- 5 Warmboard-S panel

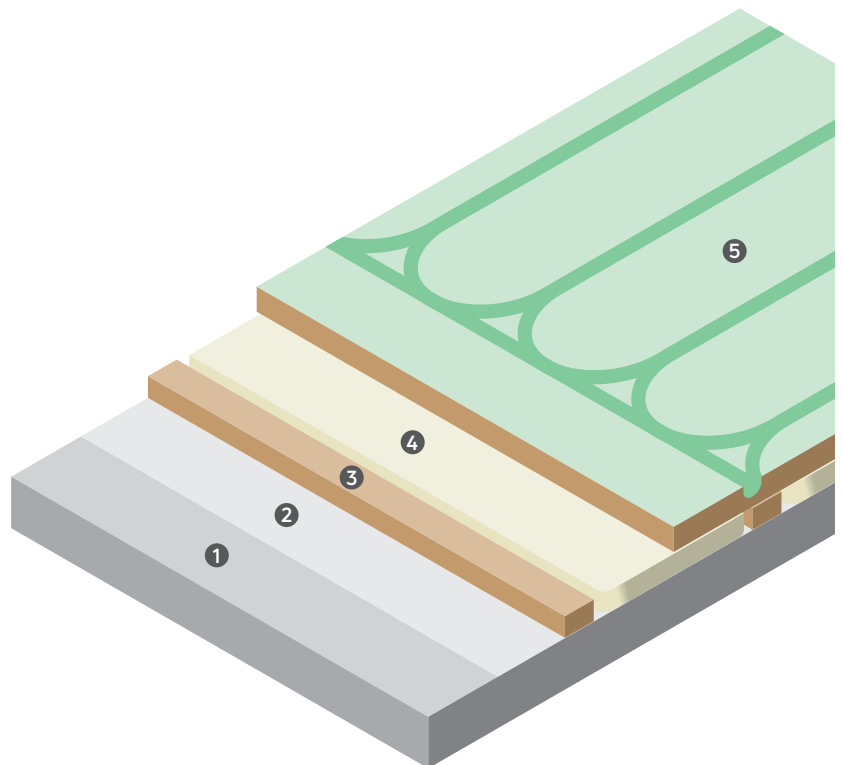

SLAB ASSEMBLIES CONTINUED...

ALTERNATIVE: DIRECT FASTEN, WARMBOARD-S

Another simple assembly method is to fasten Warmboard-S directly to the slab. This method is best when there is existing insulation beneath the slab.

After installing the selected vapor retarder, continue with the Warmboard-S installation using split drive anchors, powder actuated fasteners, or concrete screws (pg. 18).

Use a minimum of 21 fasteners per full panel, using a pattern of 3 rows of 7.

The slab **must** have sufficient drainage from rain and snow at all times. Failure to provide sufficient drainage will void any product warranty.

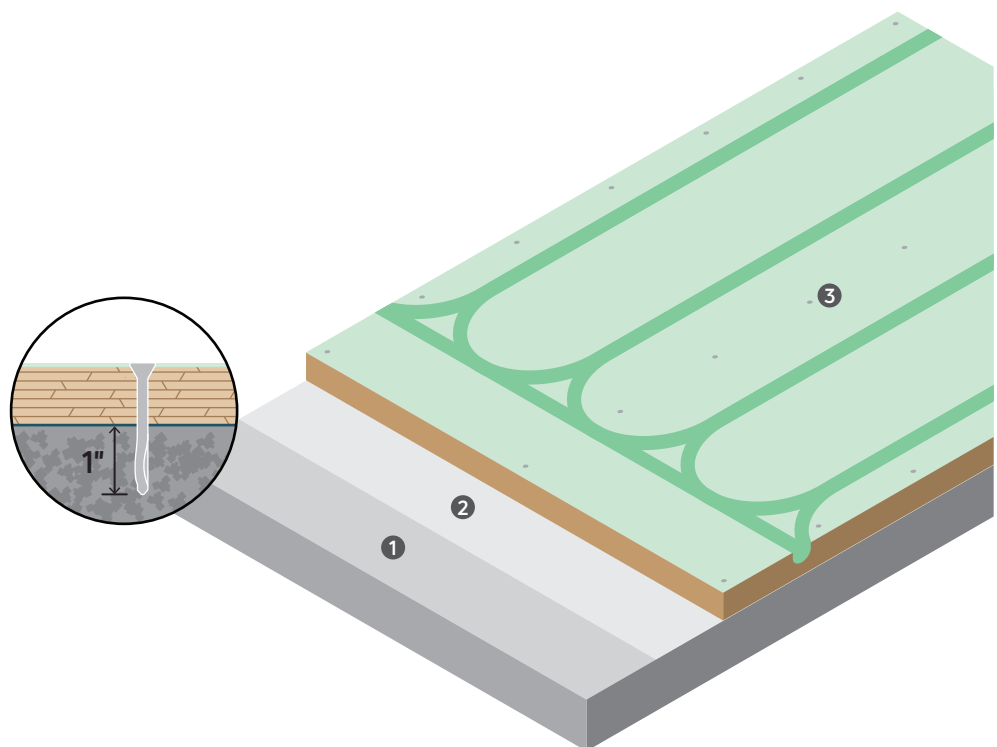

- ① Concrete/slab
- ② Vapor barrier
- ③ Warmboard-S panel

ALTERNATIVE: INSULATED, WARMBOARD-R ON FLOATING SUBFLOOR

With the growing demand for energy-efficient and sound proofed flooring products, it's increasingly common for contractors to float flooring and subflooring assemblies.

An established subfloor assembly, which can be suitable with Warmboard-R panels, consists of the following:

1. High strength rigid foam insulation is laid across the slab. In place of a vapor retarder, tape all the seams between the foam sheets to generate a continuous surface.
2. Two layers of plywood (1/2" minimum) are placed above the insulation. The top layer is glued and then screwed perpendicular to the lower layer.

Warmboard-R can now be installed onto the newly built subfloor following the instructions for subfloor applications (pg. 11). Fasteners for the subfloor, Warmboard-R, and flooring should be sized as to not puncture the insulation and tape.

The slab **must** have sufficient drainage from rain and snow at all times. Failure to provide sufficient drainage will void any product warranty.

- 1 Concrete/slab
- 2 Rigid foam insulation
- 3 Two layers, 1/2" plywood
- 4 Warmboard-R panel

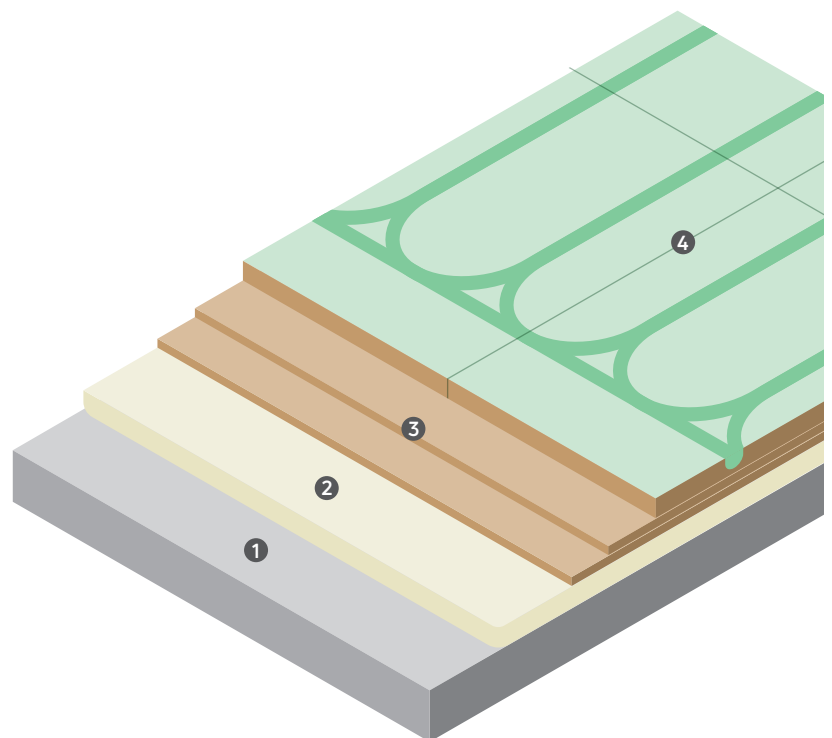

FASTENING TO SLAB

FASTENING TO CONCRETE

Pay close attention to the Panel Layout in the plan set while selecting panels to place. Align the panels as you place them by using the alignment pins supplied in the install kit. Fasten each panel before moving onto the next.

Any drilling should be done with the Warmboard panels in place (drilling the slab before placing the panels is not recommended). Due to the number of fasteners necessary, using a rotary hammer and SDS bit is recommended when drilling the slab.

Holes for anchors should be deeper than the required fastener embedment. Check your fastener's installation instructions to be sure of hole depth. Be sure to keep the bit and hole clear of debris while drilling. Finally, use a shop vacuum to remove the remaining dust from the holes.

FASTENING OPTIONS

METHOD 1

Split Drive Anchors (Flat Head)

Requires drilling each hole.

Use a sledge hammer to drive the anchors into the slab through the holes drilled for the fasteners.

This option is recommended.

METHOD 2

Concrete Screws

Requires drilling each hole.

Simply drive the concrete screws into the slab through the holes drilled for the fasteners. Concrete screws are known to bind on excess debris. Ensure the holes are clear as possible before install. For a higher price point, some companies produce heavy duty (HD) concrete screws which reduce the likeliness of a screw stripping out the concrete.

METHOD 3

Powder-Actuated Fasteners

Does not require any drilling.

Drive these fasteners directly through the panel into the slab below. Select a fastener without a washer in order to maintain a flat panel surface. This fastener type may not be the best choice for older slabs as concrete hardens over time.

This option is recommended.

1/4" flat head split drive anchor



1/4" flat head Tapcon concrete screw



0.138" Hilti X-C P8 powder-actuated fastener



Flat Head Split Drive Anchors will save you many hours of labor, but may be difficult to find in retail locations. Call 888.498.5747 or visit confast.com.



TUBING AND MANIFOLDS



CONTENT GUIDE

- ▶ Preparation Page 22
- ▶ Selecting a router Page 24
- ▶ Tubing installation Page 26
- ▶ Manifold installation Page 27
- ▶ Manifold diagram Page 28
- ▶ Tubing-to-manifold connections Page 29
- ▶ Pressure testing Page 29
- ▶ Tubing repair Page 30
- ▶ NSF official listings Page 31
- ▶ Manifold supply/return Page 31

PREPARATION

STEP 1: CLEAN THE PANELS

Clear the panels and tubing channels of debris and ensure the tubing sits flush and level.

- Use a broom, shop vacuum, or leaf blower to clear debris.
- 1/2" conduit can be helpful to break away stuck on material.

STEP 2: TUBING LAYOUT

Follow the Tubing Layout in the plan set and mark the tubing paths on the panels with a permanent marker or marking paint.

- Clearly label turns, bury points, and custom routes along the tubing path.
- Mark locations of all penetrations in the floor that may interfere with the tubing (toilet flanges, drains, water lines, forced air registers, etc).
- Label every loop path with the loop ID (manifold and loop number) using the loop marker icons in the WCS Plan Set.

STEP 3: MANIFOLD LAYOUT

When laying out the manifold placement, take the tubing runs and supply/return distribution lines into account.

- Warmboard-branded manifolds can be installed in whichever orientation best fits the install location: right side up, upside down, or sideways.
- The manifold's supply/return connections can also connect on either side.
- Mark the placement of any holes for tubing around the manifold location.

STEP 4: PLANNING HOME RUNS

To run the tubing back to the manifolds, there are a few different options. The Tubing Layout will illustrate which method is used for each loop.

METHOD 1

Use existing channels to return tubing to the manifold.

METHOD 2

Create custom routes in the panels to return the tubing to the manifold.

METHOD 3

Drill a bury point and feed the tubing to the manifold by going beneath the subfloor.

METHOD 4

Use a panel "cut back" to create a tubing channel above the slab for the tubing. Fill with Portland cement or self leveler to create a level surface.

Once a method has been determined, prepare to "cut back" panels and/or drill all the bury points.

- Use a 3/4" drill bit for your bury points. Where tubing enters the floor through a bury point, drill at a low angle or drill multiple holes side-by-side to give the tubing more flexibility in how it passes through the panel.
- A panel "cut back" can be made by either cutting out sections of panels to make space on the floor or simply moving panels out of the way.
- Reference details of the "cut backs" in your plan set and determine what type of detail works best for your installation.

Use a Sharpie or wax pencil to mark the panels.

Use a 3/4" drill bit to create a 3/4" x 1 1/2" bury point which will help prevent the tube from kinking as it passes through the panel.

Visit warmboard.com/videos for instruction.

CUT BACK DETAIL

- ① Subfloor/slab
- ② 13/16" Nailing surface
- ③ Portland Cement or Fix-It-All
- ④ Panel cut back
- ⑤ Custom route(s)
- ⑥ Warmboard panel

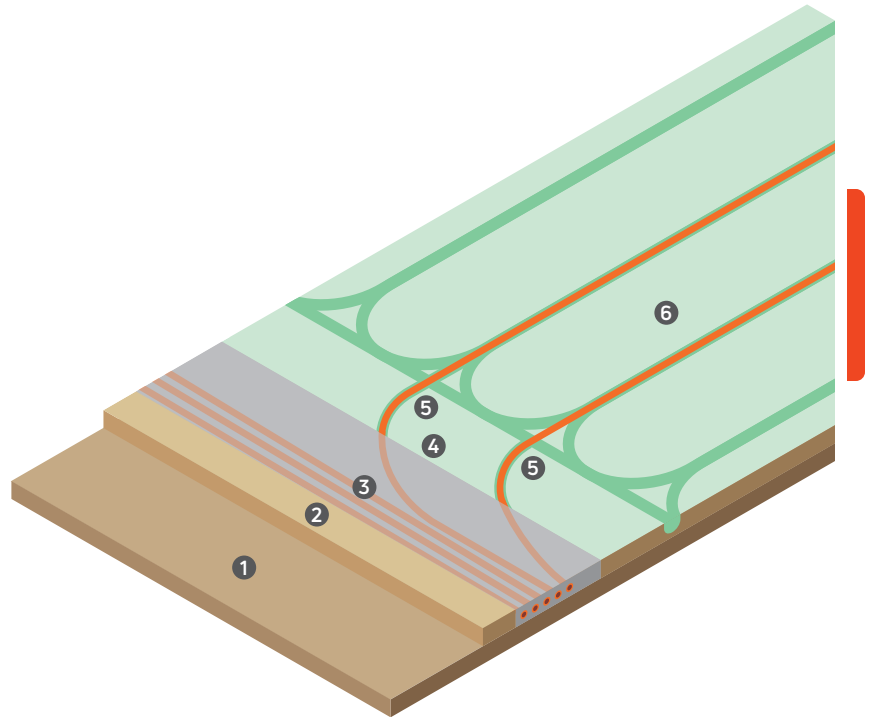

BURIED TUBING DETAIL

- ① Joist (Insulate in between)
- ② Subfloor
- ③ Bury point (Drill and deburr)
- ④ Warmboard-R panel

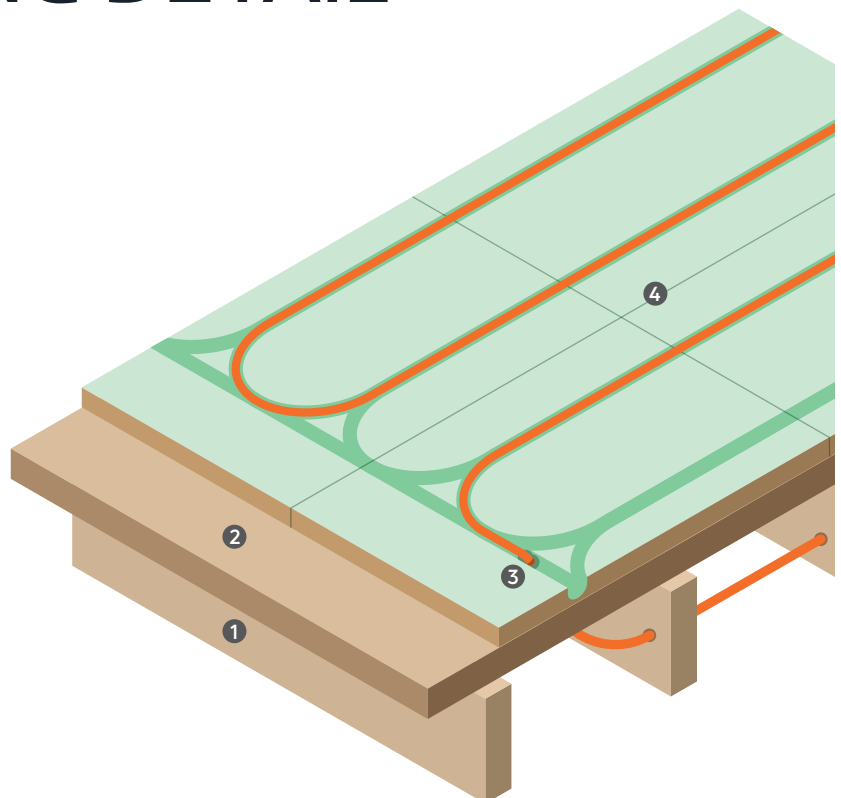

SELECTING A ROUTER

PROVIDED EQUIPMENT

The items shown below are shipped with your installation kit and should be used when routing. **Do not** attempt a route without them.

Not all sub-bases interface properly with the supplied items. **Do not** attempt a route without the correct template guide.

Consider the **Makita RF1101** router which is a readily available and a cost-effective solution.



Template guide: 25/32" I.D., 1" O.D.



Guide lock nut



5/8" Core box router bit

This is the correct sub-base with the supplied metal template guides installed.



This sub-base **does not** work with our template guide and will not create appropriate custom routes.





CREATING A CUSTOM ROUTE

Using the provided 5/8" core box router bit, grooves can be routed directly into Warmboard panels. Templates for common curves can be found in the installation kits as well as a template guide for a router. Making templates on the job site for longer custom routes may be preferred.

1. Place the router template over the desired area and fasten into position with 3 screws. Be sure the screws do not interfere with the path of the router.
2. Confirm that the router bit depth is set correctly. The tip of the bit should barely bite into the surface of the aluminum.
3. Proceed with the route.
4. Ensure the groove is smooth and consistent. If complete, remove the template guide.
5. Use a 4" grinder or deburring tool to smooth the aluminum edges for the tubing installation.
6. Use a shop vac to clear debris from the channel.
7. Place a piece of tubing into the new groove to confirm it sits level and flush with the Warmboard panel.

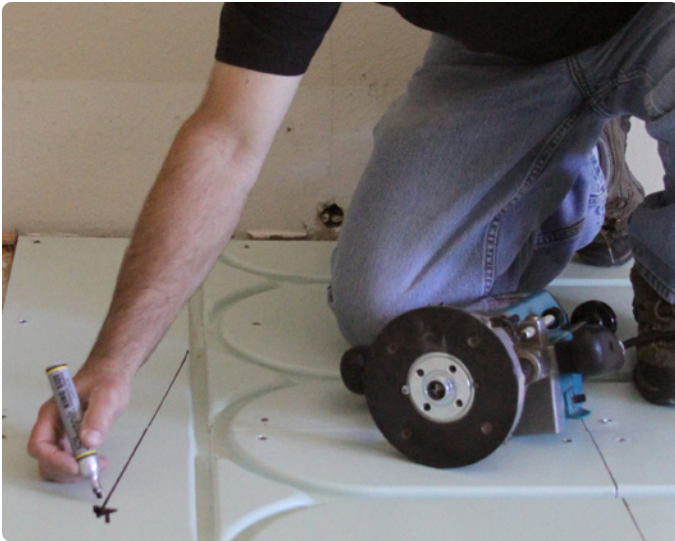

Routers need room to operate and may be difficult to use near a wall - plan accordingly. Visit warmboard.com/videos for more information.

Prolong the life of your router and bits by balancing the proper speed (RPM) with feed rate (rate of cut). A router that bogs down will cut poorly and burn out sooner. Cutting slowly with a high speed will burn out bits.

TUBING INSTALLATION

INSTALLATION TIPS

1. Tubing uncoilers will help avoid twists and kinks when installing the tubing. They are an excellent investment and highly recommended for large jobs.
2. Avoid installing tubing at temperatures below 50°F as the tubing becomes rigid and difficult to bend.
3. **Do not** use silicone or other types of adhesives in the tubing channel.
4. Tape over the ends of the tubing to prevent debris from clogging the lines.
5. Keep track of loops by labeling the tubing throughout the install process. Use the supplied loop labels provided in the installation kit.
6. Custom routes require a router with a minimum 2 hp, though 2.25 hp is recommended. **Do not** attempt a custom route without the proper template and template guides (previous page).
7. **Do not** exceed a 275 linear loop length when making field revisions.
8. Use nail plates to secure tubing as needed and remove before finish floors are installed.
9. After the tubing is installed, we recommend use of Masonite, Lauan or Ram Board in high traffic areas to help protect the tubing. Remove before installing the finish floors.

BURIED TUBING PROCESS

While there are several ways to install tubing, below is an example of how to bury tubing. If the loop does not have sections of buried tubing, start your installation process directly from the necessary manifold.

1. Mark the end of the tubing as either the supply or return.
2. Find your first bury point and measure the distance from that bury point to the manifold location.
3. Measure out that distance along the length of the tubing and make a mark on the tubing with a pen. Give yourself some extra distance so that there is enough material to work with later.
Note: Warmboard adds 15' of length to each loop.
4. Insert the tubing down into the bury point until the mark is reached.
5. Lay the tubing into the grooves in the Warmboard, following the path that was marked out on the panels.
6. Use a 16oz. rubber mallet to secure the tubing in the channel (be sure the tubing sits level and flush with the top of the panel).
7. When the next bury point is reached, measure out the distance from that bury point to the manifold.
8. Continue to meter-out enough tubing to reach back to the manifold, then cut the tubing. Remember to leave extra material for later.
9. Insert this length of tubing into the bury point.
10. Beneath the floor, route the tubing back to the manifold location. Support the tubing with straps along the way.
11. Run the supply and return through the floor at the manifold location making sure the supply terminates in the back and the return terminates in the front of the manifold location.

Tubing **must** be level and flush with the panel surface.

Consider Ram Board (or equivalent) to help protect the tubing in high traffic areas.

Warmboard adds 15 feet of length to each loop to provide additional flexibility during the installation process.

MANIFOLD INSTALLATION

INSTALLATION NOTES

- Warmboard branded manifolds can be installed in whichever orientation best fits the install location – right side up, upside down, or sideways.
- The manifold's supply/return connections can come from either side.
- While Warmboard's radiant manifolds may fit within a 2" x 4" stud bay in specific applications, for ease of install, a 2" x 6" stud bay may be the preferred location.
- Manifolds must be accessible. Finish the installation with a simple cabinet door that can be easily accessed and opened.
- Right angle ball valves are available to purchase with these manifolds if space is a consideration.

MANIFOLD INSTALLATION

All tubing and plumbing connections located at the manifolds are required to be installed by a licensed plumber or radiant heating contractor.

- Now that the tubing has been run, check your layout for the manifold placement, giving enough room for the loops and supply/return ball valves to be installed.
- Mount the manifold to plywood or blocking within the stud bay. **Do not** mount directly to the drywall.
- Ensure the drain valves on the manifolds are completely closed. The cap to the drains acts as the key for the drain's valve (hose bib).

FRAMING DIMENSIONS

Loops	Width x Height
2 Loop Manifold	14" x 36" clear
3 Loop Manifold	16" x 36" clear
4 Loop Manifold	18" x 36" clear
5 Loop Manifold	20" x 36" clear
6 Loop Manifold	22" x 36" clear
7 Loop Manifold	24" x 36" clear
8 Loop Manifold	26" x 36" clear

MANIFOLD DIAGRAM

Supply Manifold

Red, with flow meters

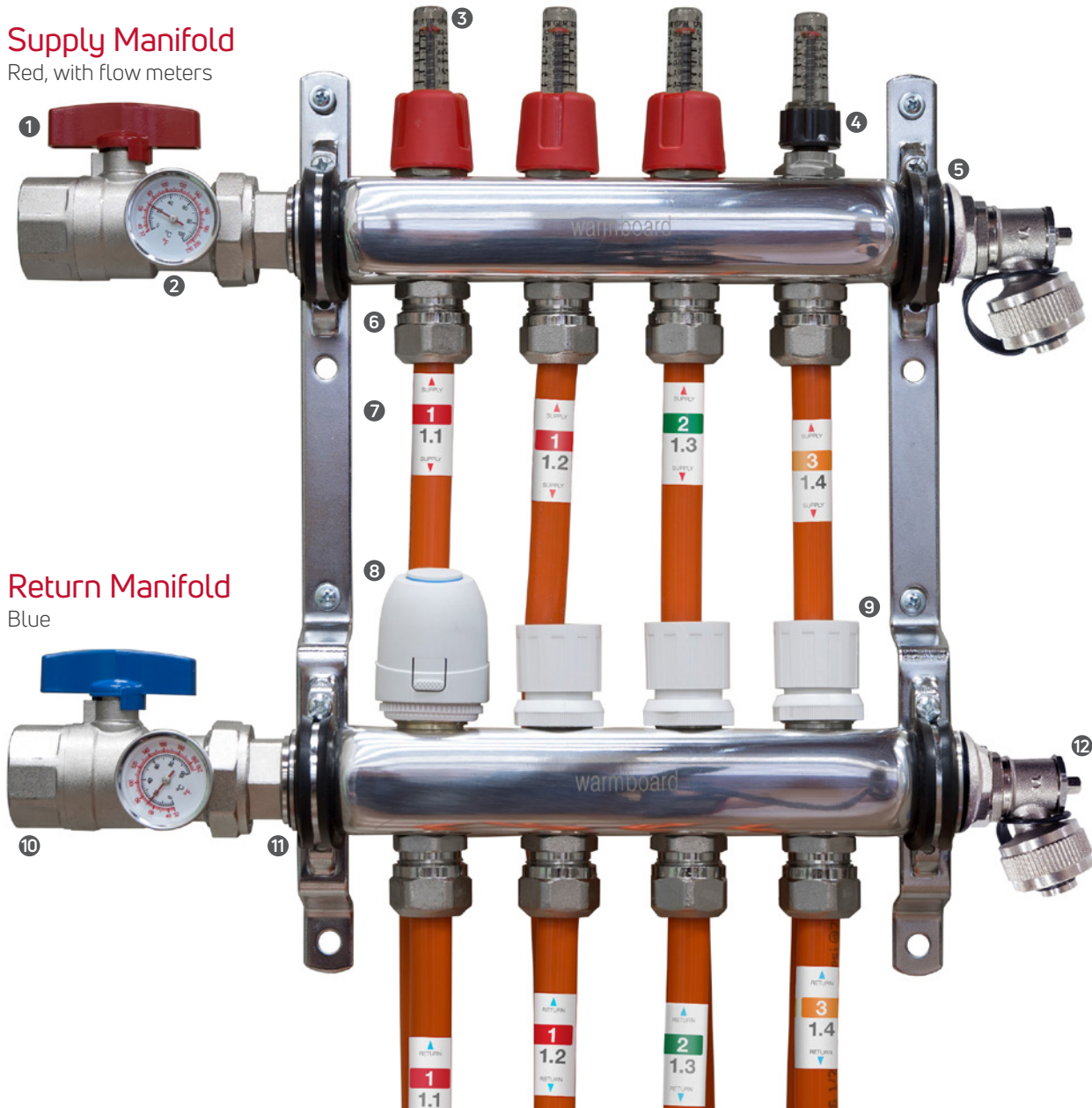

- 1 Ball valve
- 2 Temperature gauge
- 3 Sight glass, flow meter
- 4 Balance valve
- 5 Union
- 6 Manifold port, pex-to-manifold compression fitting
- 7 Tubing labels
- 8 Actuator
- 9 Valve shut off/on
- 10 1" NPT thread
- 11 1" BSPP or G1 thread
- 12 Hose bib

TUBING-TO-MANIFOLD CONNECTIONS

FITTING INSTALLATION

1. Straighten the tubing before making a square cut with the tubing cutter.
2. Use the provided stickers to label all loops at the manifold to clearly communicate the loop number and zone.
3. Use the chamfering tool provided to expand and clean up the tubing. The tubing can damage O-rings if it is not chamfered.
4. Install the compression fittings on each tube by first sliding the nuts and compression rings onto the tubing, then inserting the nipples into the end of the tubes.
5. Firmly fasten the loops to their manifold ports, but **do not** use thread seal tape or pipe dope. Avoid overtightening.

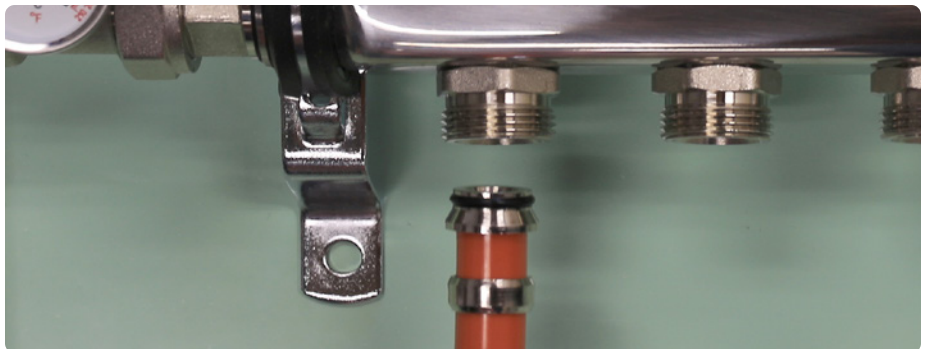

PRESSURE TESTING

USING THE TEST KIT

1. Remove both 1" ball valves on both manifolds to expose the 1" BSPP fittings. (choose either the supply or return connection)
2. Insert both the pressure gauge and end cap on the manifold and fasten securely (see images).
3. Ensure gasket on the test kit is in the proper location – it **must** be between the lock nut and the manifold.
4. The pressure test kit should seal at just above hand tight. **Do not** use thread seal tape or pipe dope to seal.
5. Air test to the mechanical code requirement of 100 PSI for 15 minutes
6. During the rest of the construction process, keep the tubing and manifolds under pressure with 60 PSI (**note**: 5–10% of the air will settle and cause the PSI to drop).



TUBING REPAIR

Should damage occur, all repairs **must** be done by a licensed plumber or radiant contractor. Warmboard offers the two types of repair couplers shown here.

METHOD 1: COMPRESSION COUPLER

Compression couplers are the standard option for tubing repair found with the T&M installation kit. This fitting has an outside dimension of 1" and will not easily fit in a Warmboard-R on slab installation.

- ▶ Warmboard-S can be chiseled away to make room for the fitting. It is also common to make the repair connection below the subfloor.
- ▶ Cut the tubing square and use the chamfering tool before installing fittings. **Do not** use thread seal tape or pipe dope to seal.

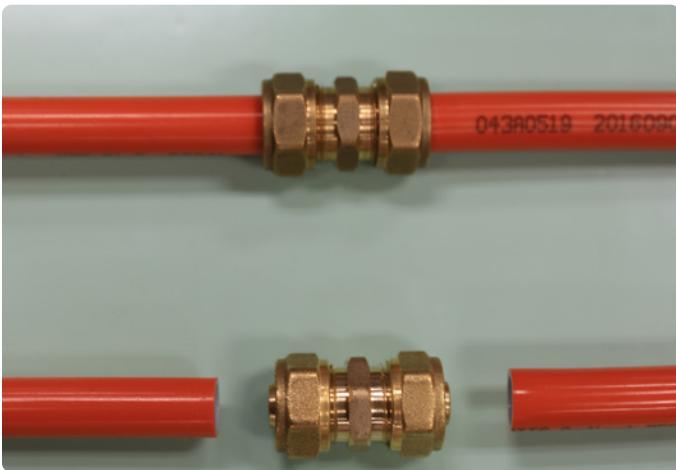

METHOD 2: PRESS COUPLER

Press couplers are a compact option for tubing repair. These stainless/brass press couplings use a specific press tool, which can be purchased from Warmboard. This fitting has an outside dimension of 13/16" and is able to fit within the depth of Warmboard-R.

- ▶ Chisel away part of the Warmboard tubing channel to accommodate the fitting.
- ▶ Cut the tubing square and use the chamfering tool before installing fittings.

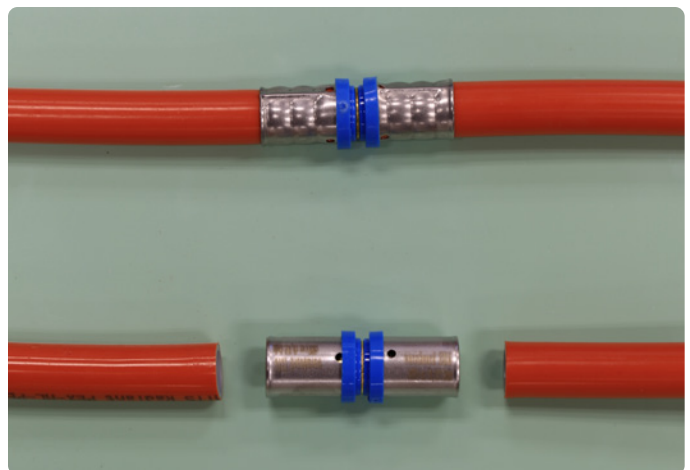

NSF OFFICIAL LISTINGS

NSF International certifies that these products conform to the requirements of NSF/ANSI Standard 14 - Plastics Piping System Components and Related Materials.

Product	Material	Supplier	Standard
Compression Fittings (F1) 1/2" – 2 1/2"	Brass 377	Warmboard	ASTM F1281
Compression Fittings (F1) 1/2" – 2 1/2"	Brass 377	Warmboard	CSA B137.10
Compression Fittings (F1) 1/2" – 2 1/2"	DZR Brass	Warmboard	ASTM F1281
Compression Fittings (F1) 1/2" – 2 1/2"	DZR Brass	Warmboard	CSA B137.10
Compression Fittings (F1-G) 1/2" – 2 1/2"	MLTPL	Warmboard	ASTM F1281
Compression Fittings (F1-G) 1/2" – 2 1/2"	MLTPL	Warmboard	CSA B137.10
Press Fittings (F5) 1/2" – 2 1/2"	Brass 377	Warmboard	ASTM F1281
Press Fittings (F5) 1/2" – 2 1/2"	Brass 377	Warmboard	CSA B137.10
Press Fittings (F5) 1/2" – 2 1/2"	DZR Brass	Warmboard	ASTM F1281
Press Fittings (F5) 1/2" – 2 1/2"	DZR Brass	Warmboard	CSA B137.10
Press Fittings (F5-G) 1/2" – 2 1/2"	MLTPL	Warmboard	ASTM F1281
Press Fittings (F5-G) 1/2" – 2 1/2"	MLTPL	Warmboard	CSA B137.10
Tubing 1/2" – 1"	PEX-AL-PEX	Warmboard	ASTM F1281
Tubing 1/2" – 1"	PEX-AL-PEX	Warmboard	CSA B137.10

MANIFOLD SUPPLY/RETURN

As shown in the plan set, the supply and return distribution lines for the radiant manifolds **must** be home run to the mechanical room.

ROUGHING IN DISTRIBUTION LINES

On the Piping Layout pages of the WCS Plan Set, the sizes and lengths for manifold distribution lines are noted.

- **Do not** move manifold locations prior to consulting with Warmboard. The distance of a manifold from the boiler was used in specifying tubing size.
- While the ball valves on the Warmboard manifolds have a 1" NPT connection, follow the piping size specified in the plan set.
- Installers may adapt the distribution piping with code compliant fittings of their choice.
- Label the supply and return lines in the rough-in stage.
- Be aware that use of excessive fittings can increase system headloss. Use PEX fittings sparingly as they obstruct fluid flow.

MEP: ELECTRIC

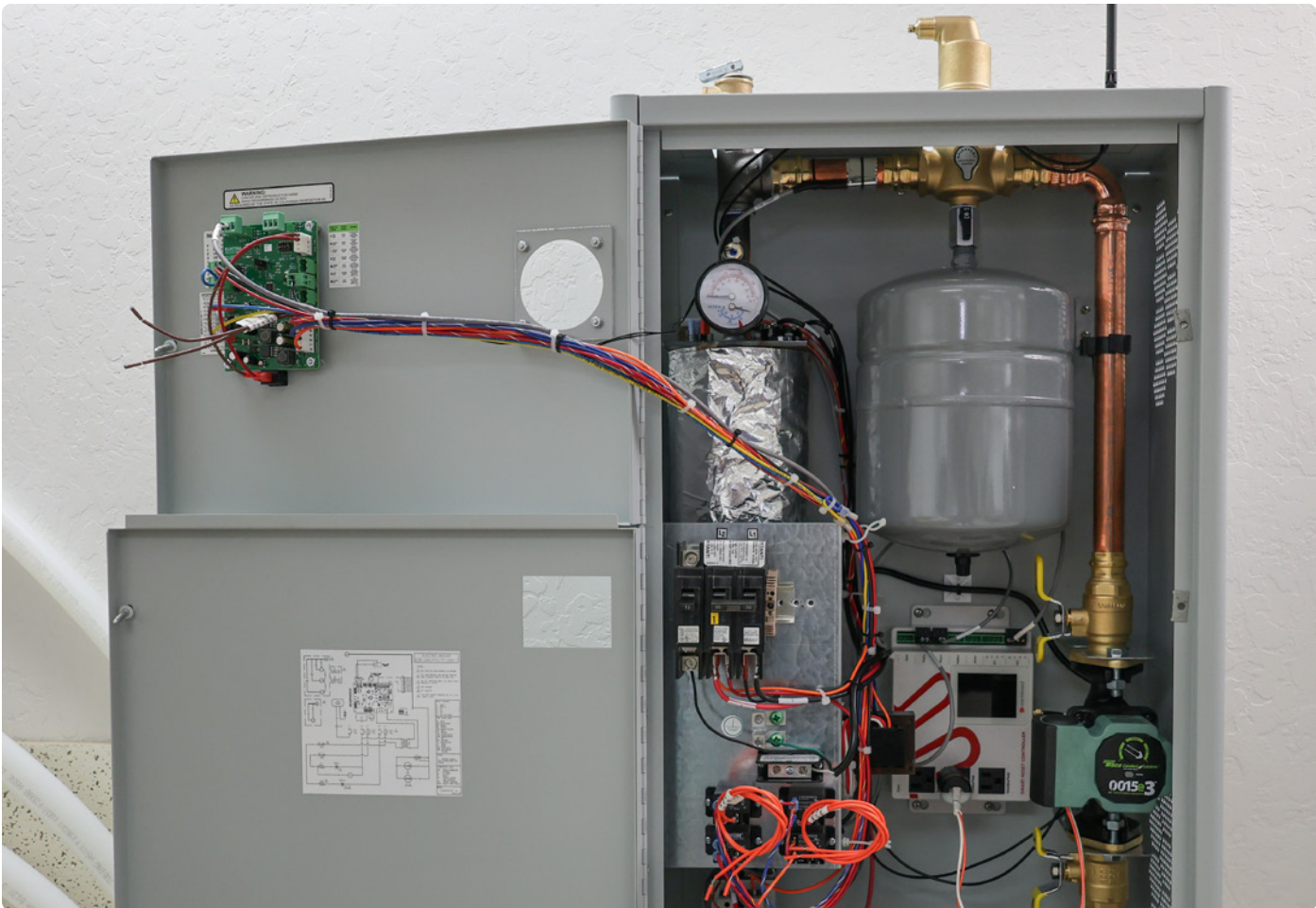

CONTENT GUIDE

- ▶ Mechanical components Page 34
- ▶ Electrical rough-in Page 35
- ▶ Specification: Warmsource-E Page 36
- ▶ Specification: Warmsource-E Page 37
- ▶ Warmsource-E installation Page 38
- ▶ Filling and purging Page 39
- ▶ Construction Mode Page 40
- ▶ Setting flow Page 41
- ▶ Diagnostic Mode Page 42

MECHANICAL COMPONENTS

INCLUDED, PRE-PLUMBED

The following components are pre-plumbed inside the Warmsource-E unit:

- ▶ Automatic air vent
- ▶ Taco ECM variable speed circulator
- ▶ Temperature and pressure (T&P) relief valve
- ▶ Expansion Tank

INCLUDED, NOT PRE-PLUMBED

The following are included with Warmsource-E but **not** pre-plumbed. Refer to the WCS Plan Set for location and pipe sizing:

- ▶ 1 1/4" combo hose bib/ball valve.
- ▶ Additional 1" or 3/4" combo hose bib/ball valves (for component isolation and easy air purging)
- ▶ Additional expansion tank (if required)
- ▶ Backflow Preventer
- ▶ Pressure Reducing Valve

WCS DESIGN DRAWINGS

Our WCS Plan Set lists all the necessary plumbing and mechanical materials. Reference this document regularly. Before proceeding, make sure all boiler components are pre-plumbed per the Electro Boiler manual, including:

- ▶ T&P relief valve discharge
- ▶ 1/2" cold water line from the domestic water supply to the pressure reducing valve (WCS Plan Set)



ELECTRICAL ROUGH-IN

The WCS controls equipment needs access to power at all equipment locations across the project. Each piece of equipment will likely require its own junction box. Often manifolds may share a single install location and are permitted to share duplex receptacles.

The controls diagram in the WCS Plan Set illustrates how each piece of equipment should be powered.

WARMSOURCE-E POWER

The Warmsource-E has a range of sizes and power requirements:

- ▶ EZB-M2-07-240-1 Breaker: 45 A
- ▶ EZB-T1-07-240-1 Breaker: 45 A
- ▶ EZB-M2-09-240-1 Breaker: 60 A
- ▶ EZB-M2-12-240-1 Breaker: 45 A, 45 A
- ▶ EZB-M2-15-240-1 Breaker: 60 A, 45 A
- ▶ EZB-M2-18-240-1 Breaker: 60 A, 60 A
- ▶ EZB-T1-20-240-1 Breaker: 60 A, 60 A

CONTROLS EQUIPMENT POWER

The Controls Diagram in the WCS Plan Set contains the electrical specifications of the controls equipment:

- ▶ Thermostat: 120 VAC, 0.5 A,
Circuit shared by thermostats (preferred).
- ▶ Manifold Controller: 120 VAC, 2.1 A,
Circuit shared by manifold controllers (preferred).

Thermostats may be simply cut in above light switches and manifold controllers may be added onto existing circuits. However, it is almost always a better practice to put the thermostats and manifold controllers onto a single circuit.

Reference the Equipment and Piping Layout in the WCS Plan Set for specified equipment location.

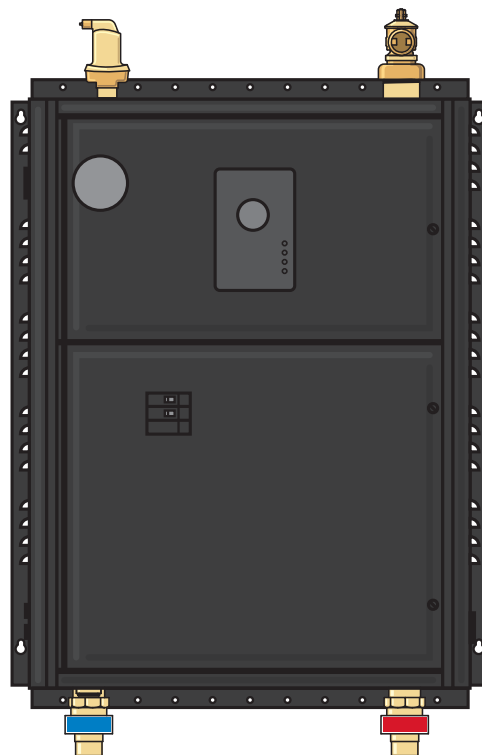

Follow local code for fuses and disconnects.

Wiring can be run from the left or right side of the unit.

SPECIFICATION: WARMSOURCE-E

Electro-Boiler Model EZB-T1

Dimensions: 25^{3/8}" w x 33^{1/2}" h x 13^{1/4}" d

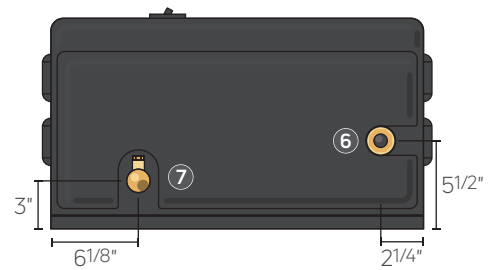
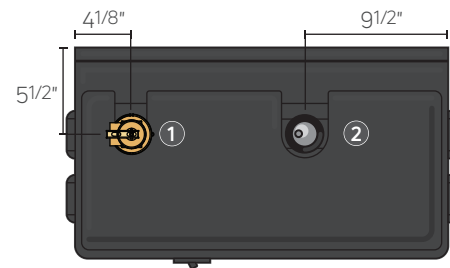
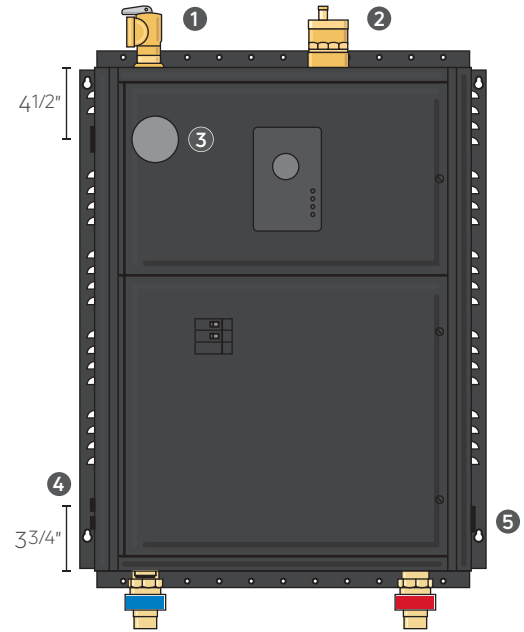

- ① Pressure relief drain connection, 3/4" NPT
- ② Air eliminator
- ③ Gauge
- ④ 1-11/4" conduit
- ⑤ 1/2 - 3/4" conduit
- ⑥ Supply
- ⑦ Return

SPECIFICATION: WARMSOURCE-E

Electro-Boiler Model EZB-M2
Dimensions: 21⁷/₈" w x 33³/₈" h x 12" d

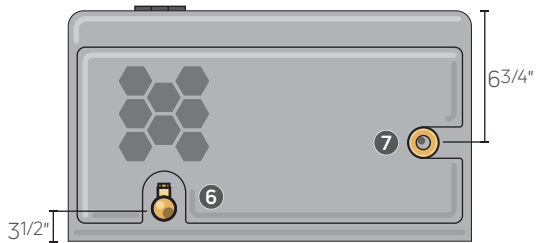
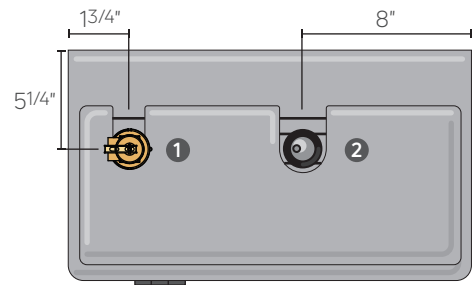
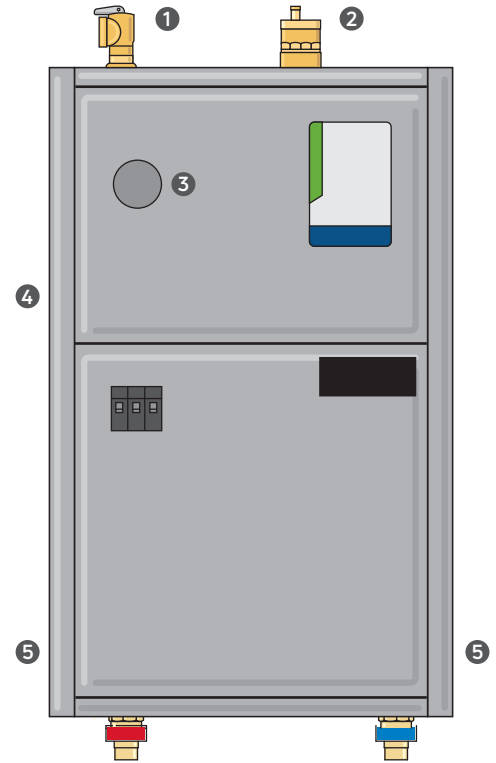

- 1 Pressure relief drain connection, 3/4" NPT
- 2 Air eliminator
- 3 Gauge
- 4 1-1/4" conduit
- 5 1/2 - 3/4" conduit
- 6 Supply
- 7 Return

WARMSOURCE-E INSTALLATION

INSTALL LOCATION

Before installing Warmsource-E, it's important to consider its location. Like all electric boilers, Warmsource-E does make a small amount of noise, which may be disruptive if installed near a bedroom or common living space. Garages and basements are the better choice. Installation of a drain pan, especially in living spaces, is highly recommended.

MINIMUM CLEARANCES

This illustration shows the recommended minimum dimensions for the Warmsource-E mechanical room. Note that this view also depicts space needed for piping and mechanical components. The minimum depth is 40" for access and serviceability.

MOUNTING WARMSOURCE

The Warmsource can be mounted with the use of a mounting bracket or using the mounting holes on the flange of the cabinet.

- Fasten the mounting bracket to the Warmsource-E with the supplied bolts. Mount the cleat to the wall using whichever holes allow fasteners to land on studs. Finally, lift Warmsource-E onto the wall.
- If not using the mounting brackets, the use of blocking before drywall or ledgers after drywall may be necessary to securely mount the boiler.
- Review the Electro Industries manual for minimum clearances and dimensions.

CONNECTIONS

Warmsource

- Connect the pressure relief drain line per the Electro Industries manual and local code.

System Piping

- Build the distribution header according to the Mechanical Diagram in the WCS Plan Set.
- Connect all supply and return lines at the manifold.
- Plumb the water feed from the domestic water on the job site per the Mechanical Diagram in the WCS Plan Set.

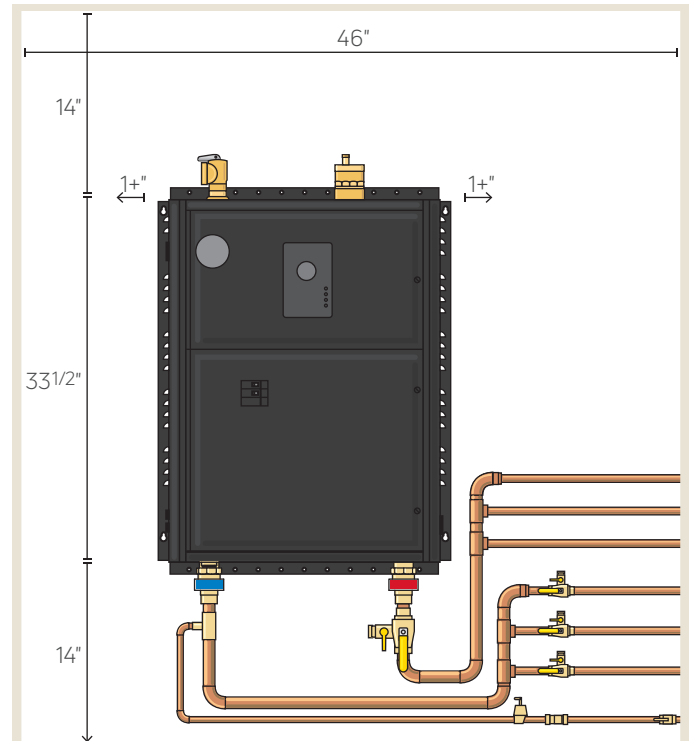

A minimum width of 46" is recommended when including distribution lines. A minimum clearance of 1" is recommended on either side of the unit.

Install the Warmboard-supplied ball valves and hose bibs as shown in our WCS Design Drawings to properly fill and purge air from the system.

View the Mechanical Diagram in the WCS Plan Set to see how the manifold distribution lines should be plumbed, and get a better idea of labor costs.

FILLING & PURGING

Once the system is plumbed and the manifolds are pressure tested with air, the next step is to fill the system with water and purge air from the lines, which in a closed loop system can create noise and inhibit the flow of water.

PURGE AIR, FILL WITH WATER

Follow these steps to fill and purge the air in the system. This should be done one manifold at a time. In this example, begin with **Manifold 1** (see image).

SECONDARY LOOPS

1. Remove any white valve caps or actuators that may be on the manifolds.
2. Close **Ball Valves (A-C)** and ensure **Ball Valve D** is open.
3. If closed, open the **Shutoff Valve (G)** for the water feed to the system. Air should begin to release from air vents.
4. Thread a discharge hose to **Hose Bib A** and run the other end of the hose outside or to a drain.
5. Open **Hose Bib A** and lift the fast-fill lever on the **Pressure Reducing Valve (E)**. Water should make its way through the first manifold and out of the hose.
6. Ensure the flow meters are registering flow through the manifold. If not, confirm the supply and return are plumbed appropriately.
7. If any loops are not showing flow, restrict the neighboring balance valves to force flow to the affected loop(s).
8. Continue filling the system until air stops discharging and only water is leaving the hose.
9. Once all air has been discharged from that manifold, release the fast-fill lever and quickly close **Hose Bib A**. Avoid spiking system pressure with the fast-fill.
10. Repeat this process on the rest of the **Manifolds (B, C)** until the whole system is filled.
11. When done, turn off the water, close all hose bibs on the system, remove all hoses, and open all ball valves.

Reference the Electro Industries EZB manual for allowable mineral levels and quality of the water. Filtered water or a corrosion inhibitor may be required.

PROPYLENE GLYCOL

In some situations, it may be necessary to add propylene glycol to prevent freezing. Instead of adding water from a water feed, close **Ball Valve D** and transfer fluid into **Hose Bib D** from a reservoir of glycol solution via a transfer pump. At the same time, discharge glycol solution from **Hose Bib A** back into the reservoir. Follow order of operations similar to the previous purge process. Once one manifold is no longer discharging air, close **Ball Valve D** followed by **Hose Bib A**. Perform these steps with **Manifold 2**.

Propylene glycol should **only** be used for freeze protection. Follow guidelines found in the WCS Plan Set for the correct mix (generally 10-30%).

To fill the system with a propylene glycol/water solution, we recommend a Liberty 331 Portable Transfer Pump, or equivalent (homedepot.com).

To maintain the propylene glycol feed for many years, we recommend plumbing a glycol feeder in place of the water feed on the Mechanical Diagram.

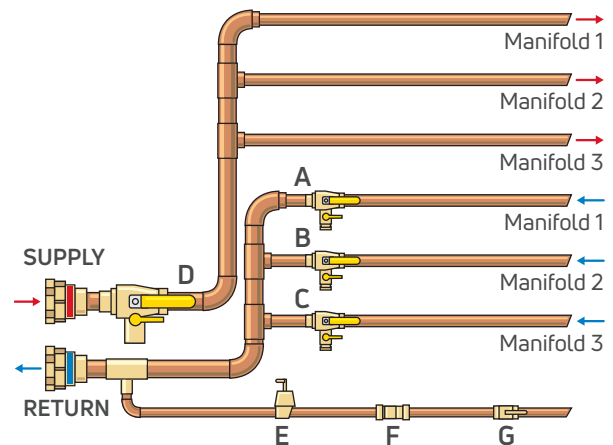

A, B, C 3/4" Combo ball valve/hose bib*

D 1 1/4" Combo ball valve/hose bib

E Fast fill lever/pressure reducing valve

F Backflow preventer

G 1/2" ball valve

*Size according on WCS Plan Set

CONSTRUCTION MODE

Construction Mode is a control loop in which the primary pump, secondary pump, and boiler run without Comfort System thermostats or manifold controllers.

Once the system is properly filled, use Construction Mode to heat the structure before thermostats, MC(s) and actuators are installed. Construction Mode offers the opportunity to:

- ▶ Remove air from the system.
- ▶ Balance and set flows rates.
- ▶ Heat an active job site and hasten the release of moisture from building materials (paint, plaster, hardwood flooring and other wood materials).

BOILER START-UP WITH CONSTRUCTION MODE

1. Open both the upper and lower doors on the cabinet.
2. Power the unit by switching the breakers, on the face of the Warmsource, to the **On** position.
3. The display on the SRC in the cabinet will start up and display the main menu.
4. In the menu, navigate to **Construction Mode**.
5. Select a supply water temperature and your preferred control option (**Timed** or **Thermostat**) before turning on Construction Mode. You cannot adjust these settings while Construction Mode is running.

TIMED

This setting allows the system to modulate heat output by reducing the run time of the boiler. In this mode, the desired Heating and Idle times can be set. The unit will cycle between **Heating** and **Idle** once Construction Mode is turned on. If **Idle** is set to zero, Construction Mode will heat indefinitely.

THERMOSTAT

In this mode a dry contact thermostat can be wired to the bottom two terminals of the port labeled **Sensor** (see image).



Construction Mode **must** be turned off before any settings can be changed.

Warmsource is pre-set at our factory to maintain proper temperature control and operation. **Do not** adjust.

Do not use Construction Mode after any actuators have been installed.

SETTING FLOW

In order for the system to heat evenly and maintain the proper temperatures on design day conditions, flow rates must be set at the manifolds.

The ideal time to adjust the flow rates is during Construction Mode, before the controls are installed, when all loops open and flowing.

SUGGESTED PROCESS FOR SETTING FLOW

Before setting flow, remove the red sleeves from the balances valves on every manifold and ensure the balance valves are fully open (three turns counter-clockwise [CCW] from the closed position). Once done, follow these steps starting at the manifold location closest to the Warmsource:

1. Reference the Radiant Design Data in the WCS Plan Set for the specified flow rates.
2. Adjust each balance valve until the flow meter registers the designed flow rate. Avoid touching the sight glass, and turn CW to close and CCW to open. The red plunger in the flow meter should sit at the graduation which corresponds to the specified flow rate.
3. Once the manifold has been completely adjusted, move to the next closest manifold to repeat the process.
4. When all the manifolds have been adjusted, perform a walk through on all adjusted manifolds. Readjust flows where they may have changed during the process and replace the red caps onto the balance valves.

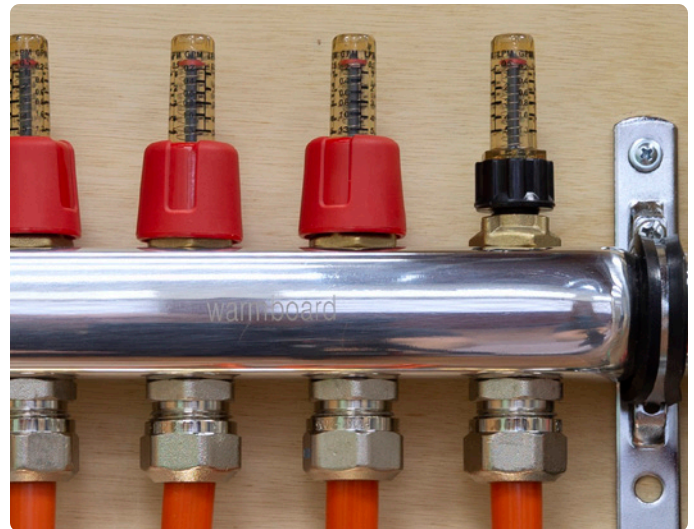

Listed flow rates are minimum values. It is acceptable to increase flow rates in a zone as long as all loops increase flow relative to each other in that zone.

To set flow on a system with manifold controllers installed, use the **Open All Loops** command in conjunction with the Secondary Pump relay control in Diagnostic Mode.

DIAGNOSTIC MODE

Diagnostic Mode is a simple control loop which allows a technician to directly control the relays and valves on the SRC. This can be used to verify relays, confirm certain components are functioning, and reset the SRC.

RUNNING DIAGNOSTIC MODE

1. Tap the screen on the SRC, then scroll to and tap **Diagnostic Mode**.
2. Press the grey **Power icon** next to **Start Diagnostic Mode**. The icon will turn green.
3. Actuate relays by toggling the corresponding icons on and off. Avoid running the secondary pump without open loops in the system.
4. Once done, turn off Diagnostic Mode by pressing the **Power icon** again.



Avoid dead heading the secondary pump for extended periods of time.

After an hour of inactivity, the SRC will exit Diagnostic Mode.



FLOORING

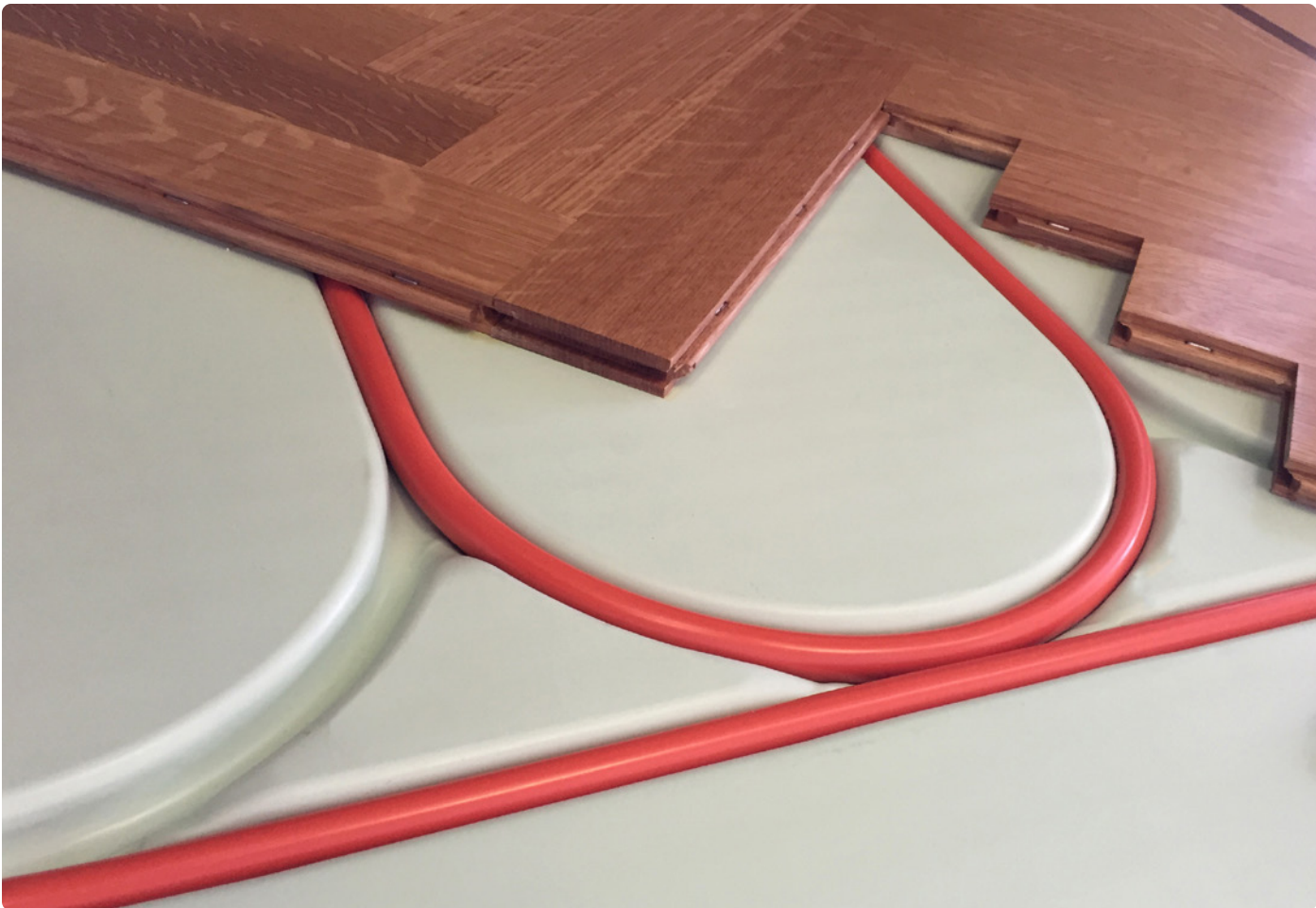

CONTENT GUIDE

► Flooring R-values	Page 46	► Carpet	Page 63
► Hardwood manufacturers	Page 47	► Cork	Page 64
► Hardwood flooring	Page 48	► Vinyl and linoleum	Page 65
► Hardwood acclimation	Page 49		
► Solid plank and engineered assemblies	Page 50		
► Sound control assemblies	Page 51		
► Installing tile	Page 52		
► Backer board	Page 53		
► Backer board stencil	Page 54		
► Mud bed, Mapei	Page 55		
► Self-leveling underlayment, Mapei	Page 56		
► Uncoupling membrane, Blanke	Page 57		
► Uncoupling membrane, Mapei	Page 58		
► Uncoupling membrane, Schluter	Page 59		
► Uncoupling mat, Redgard	Page 60		
► NXT Level, Laticrete	Page 61		
► STRATA_MAT, Laticrete	Page 62		

FLOORING R-VALUES

Flooring	Thickness	Avg. R-value	R-value/inch
Softwood	3/4"	0.825	1.10
Ash	3/4"	0.75	1.00
Fir	3/4"	0.90	1.20
Maple	3/4"	0.75	0.75
Oak	3/4"	0.638	0.85
Pine	3/4"	0.975	1.30
Engineered bamboo	3/4"	0.72	0.96
Engineered wood	1/4" 3/8" 5/8" 3/4"	0.25 0.375 0.625 0.750	1.0
Carpet	1/4" 3/8" 1/2" 5/8" 3/4"	0.70 1.05 1.40 1.75 2.10	2.80
Wool carpet	3/8" 1/2"	1.575 2.10	4.20
Vinyl (sheet)	1/8"	0.20	1.60
Vinyl, (composite tile)	1/8"	0.20	1.60
Linoleum	1/8" 1/4"	0.20 0.40	1.60
Cork	3/8"	1.125	3.00
Cork/MDF/Laminate	1/2"	1.175	2.35
Brick	1 1/2"	3.375	2.25
Marble	1/2"	0.40	0.80
Ceramic tile	3/8"	0.375	1.00

Underlayment	Thickness	Avg. R-value	R-value/inch
Plyboo	3/4"	0.825	1.10
OSB	3/4"	1.05	1.40
Engineered wood flooring pad	1/8"	0.20	1.60
Carpet pad/Slab (rubber) 33 lb.	1/4" 3/8" 1/2"	0.32 0.48 0.64	1.28
Carpet pad/Waffle (rubber) 25 lb.	1/4" 1/2"	0.62 1.24	2.48
Hair jute	5/16" 1/2"	1.25 1.94	3.88
Prime urethane	5/16" 1/2"	1.40 2.15	4.30
Bonded urethane	5/16" 1/2"	1.35 2.1	4.20
Dense rubber flooring	5/16"	0.25	1.30
Recycled rubber flooring	1/2"	1.10	2.20
Thin-set mortar	1/8"	0.05	1.00
MDF/Plastic laminate	1/2"	0.50	1.00
Laminate floor pad	4/25"	0.30	1.92

HARDWOOD MANUFACTURERS

Hardwood manufacturers who endorse their products for use with Warmboard. Other brands can also be installed.

Arrigoni Woods

arrigoniwood.com // 888.423.6668

Mill & Woods

millandwoods.com // 800.283.6038

Boen Hardwood Floors

boen.com // 888.897.0800

BR-111 Exotic Hardwood

br111.com // 800.525.2711

Carlisle Wide Plank Floors

wideplankflooring.com // 800.595.9663

Craft Artisan Hardwood

craftfloor.com // 877.828.1888

Dinesen

dinesen.com // +45.7455.2140

Gaylord Hardwood Flooring

gaylordhardwoodflooring.com // 877.333.0433

The Heartpine Company

heartpinecompany.com // 434.234.8199

Homerwood Hardwood

homerwood.com // 814.827.3855

Junckers Hardwood Floors

junckershardwood.com // 800.878.9663

Kahrs Flooring

kahrs.com // 800.800.5247

Lauzon Hardwood Flooring

lauzonflooring.com // 800.665.6765

mafi

mafi.com // 1.917.488.0410

Mirage Floors

miragefloors.com // 800.463.1303

Mountain Lumber

mountainlumber.com // 800.445.2671

Monarch Plank Hardwood

monarchplank.com

Plyboo

plyboo.com // 866.835.9859

Schotten & Hansen

schotten-hansen.com

Signature Hardwoods

signaturehardwoods.com // 866.554.4252

Southern Wood Floors

southernwoodfloors.com // 888.488.7463

Vermont Plank Flooring

vermontplankflooring.com // 866.804.9587

Vintage Flooring

vintageflooring.com // 877.256.0231

HARDWOOD FLOORING

HARDWOOD RECOMMENDATIONS

Solid sawn hardwood planks have been an integral part of architecture for over 400 years. Since 1998, more than 40 million square feet have been successfully installed over Warmboard. The long-documented history of hardwood, combined with our decades of experience, confirms that traditional 3/4" solid plank flooring is the gold standard. Accordingly, it remains our strong recommendation.

All wood products expand and contract with changes in humidity. Solid plank wood is naturally monolithic and expands and contracts most evenly. When these dimensional changes do occur, cupping, crowning and gapping at the edges may result. These changes are inherent to all wood flooring, regardless of the heating method. To minimize such dimensional changes, especially as humidity varies throughout the seasons, we also recommend quartersawn and/or rift cut planks due to their stability.

To limit dimensional movement, ensure the hardwood has the proper moisture content at the time of installation. A good hardwood installer will know the ideal range for your geographic region. A moisture meter is required to determine when that moisture percentage is achieved.

Whether using plank, engineered or laminate wood flooring, there have been thousands of successful installations over Warmboard covering tens of millions of square feet.



A WORD ABOUT ENGINEERED FLOORING

Numerous engineered flooring products have been developed in recent years. With each product comes variations in material, assembly method, dimensional stability and overall quality. Warmboard is unable to test every iteration of these products and therefore cannot express an informed opinion on how variations in humidity may impact their dimensional stability. We leave it to the consumer to do their own due diligence to determine any particular engineered product's suitability for their project.

A WORD ABOUT FLOORING THICKNESS

Many mistakenly believe that a radiant floor cannot have 3/4" thick floor coverings. This thinking is based on a theory that the resulting higher R-value prevents the system from adequately heating the space. This may be true for low conductivity radiant panels, but not Warmboard. Apart from the fact that thicker hardwood, all things being equal, is better quality, its increased R-value causes more even heat across your floor with the result that your feet will not be able to tell where tubing is and isn't. With thinner material, the temperature variation across the tubing is increased causing what is known in the radiant industry as "striping" which makes your floor less comfortable. And comfort is the primary reason for Warmboard's existence, which is why we recommend using 3/4" hardwood over our panels.



HARDWOOD ACCLIMATION

HARDWOOD FLOORING ACCLIMATION

Before the hardwood is on site, ensure the interior plastering is complete (and dry), and that the radiant system has been operating for a couple weeks in order to reduce any excess moisture from the Warmboard panels. In some locales, you may need to operate the air conditioner simultaneously with Warmboard to lower the indoor humidity. The hardwood should experience consistent, low humidity once on site.

Consider any moisture or humidity intrusion that may take place in the future, such as a crawl space beneath the Warmboard panels, which could be dry in the summer and experience water intrusion in the winter. This could cause large humidity swings and excess movement of the hardwood flooring.

Once the interior space is properly conditioned to the desired relative humidity, bring in the wood planks and sticker them - pulling the planks out of their boxes and setting them up so air can circulate around them.

Prior to flooring installation, the moisture content of the Warmboard panels should be 12% or less. The moisture content of the finish hardwood should be between 6-9%, though this will vary by climate zone. Be sure to discuss this with your flooring installer.

It will be difficult to get a moisture reading from Warmboard due to its aluminum surface, so we recommend a moisture meter with insulated contact pins and hammer probe. The Delmhorst J4 and J2000 models (delmhorst.com) are good options which can be upgraded with pins and hammer probe.

INTRODUCING HEAT TO FLOORING

As part of the Warmboard Comfort System, Construction Mode may be used to adjust newly installed flooring to the temperatures of radiant heating. As warm water is circulated through the floors, the water temperature can be gradually increased over several days. For example, the temperature setting on the Construction Mode page could be adjusted in daily increments from 90°F to 110°F.



Keep low moisture levels in the hardwood to ensure long term stability. Maintain an indoor ambient temperature of 60-80°F (15-26°C), and the humidity between 30-50%.

SOLID PLANK AND ENGINEERED ASSEMBLIES

APPROVED ADHESIVES

Only use adhesives listed here.

Failure to use an approved adhesive will void any product warranty.

- ▶ Bona R850T, R851, R859
- ▶ Bostik's BEST, BST, Climb, EFA+, GreenForce, HDAC, ProCure, Pro-MSP, Ultra-Set SingleStep 2, Vapor-Lock
- ▶ Mapei Ultrabond Eco 975, 980
- ▶ Sikabond T-35 and T-55
- ▶ Stauf Adhesives PUK-455 Wide Plank Adhesive, PUM-950 Power Mastic
- ▶ Titebond 771, 811, 821
- ▶ Wakol MS 230, MS 232, MS 260, MS 262, MS 290, MS 292, MS 245/246, PU 224, PU 385

Approval letters from these companies are available upon request.

METHOD 1: NAIL DIRECTLY

Installing hardwood perpendicular to the tubing pattern is the best method as it allows you to see the tubing and avoid damaging it. Tongue nail at a 45° angle at 6" on centers and use flooring nails sized depending on the subfloor and flooring selection. Fasteners should not penetrate through the bottom of the subfloor.

Occasionally, plank flooring may need to run the same direction as a section of tubing, and nailing the plank could cause tubing damage. Should this occur, either glue with an approved adhesive or face nail the plank. While the planks can be successfully nailed down parallel to the tubing pattern, this method may require extra labor. Strategic planning with the layout can avoid face nailing and gluing in many locations.

METHOD 2: NAIL & GLUE DIRECTLY

Aside from the glue itself, you do not need to install additional material between the Warmboard panel and the hardwood. Either apply flooring adhesive with a trowel or applicator gun.

Installing hardwood perpendicular to the tubing pattern is the best method as it allows you to see the tubing and avoid damaging it. Nail the planks following the same methods as described previously.

Occasionally, plank flooring may run the same direction as the tubing, and nailing the plank could cause tubing damage. Should this occur, **do not** nail - the glue will successfully bond the plank to the Warmboard panel.

You **must** lower the moisture content of your hardwood prior to installation.

Only use the approved adhesives listed in this guide. Failure to do so will void any product warranty.

When installing hardwood parallel to the tubing, rip the first plank at an appropriate width to create a nailing pattern which will avoid the tubing at all T&G locations.

Watch our hardwood installation video: warmboard.com/videos



METHOD 3: GLUE DIRECTLY

Aside from the glue itself, there is no need for additional material between the Warmboard panel and hardwood. Apply the flooring adhesive with either a trowel or applicator gun.

METHOD 4: FLOATING FLOOR

With this option, floorboards are not nailed or adhered to the Warmboard panel. Instead, interlocking flooring or edge glued flooring, is freely laid down onto the subfloor allowing the whole floor to move as a single unit if a dimensional change within the floor takes place.

We highly recommend using acoustic padding between Warmboard and the planks. Consider Roberts' AirGuard Premium 3-in-1 Underlayment with Microban.

SOUND CONTROL ASSEMBLIES

UNDERLAYMENTS

Reducing sound transmission can be as simple as buying a readily available sound control underlayment and installing it to the specification of that manufacturer. It is best practice to fill empty tubing channels with scrap tubing or a self leveling product before applying the underlayment.

TESTED ASSEMBLIES

Warmboard has over 10 Sound Transmission Class (STC) and Impact Insulation Class (IIC) rated assemblies available for both Warmboard-S and Warmboard-R. These include floating, glued, and nailed assemblies that may meet customer needs.

INSTALLING TILE

TESTING AND APPROVALS

We provide instruction for nine assemblies for tile or stone over Warmboard. These methods have been tested and approved by the product manufacturers, the Tile Council of America (TCNA) or both. These tests provide an expert third party endorsement for best practices when installing tile and stone over Warmboard radiant panels.

Note: Warmboard-R has not been tested by the TCNA. However, due to the near identical properties of the panel, we are convinced that Warmboard-R would perform equally under the testing conditions. Our extensive experience in the field supports this.

Using tile or stone over Warmboard radiant panels is subject to all of the tile setting requirements of any standard wooden subfloor.

Robinson Floor Test (ASTM C627) results are available upon request. Approval letters and test results for each assembly are also available upon request.

TCNA RATINGS & DESCRIPTION

Residential (homes)

Tile survived 3 cycles of testing with no damage

Light Commercial (offices, etc.)

Tile survived 6 cycles of testing with no damage

Moderate (hospitals, etc.)

Tile survived 10 cycles of testing with no damage

Heavy (shopping malls, etc.)

Tile survived 12 cycles of testing with no damage

Extra Heavy (airports, etc.)

Tile survived 14 cycles of testing with no damage

RECOMMENDED ASSEMBLIES

METHOD 1: Backer board

TCNA Rating: Extra Heavy

METHOD 2: Mud bed, Mapei

TCNA Rating: Extra Heavy

METHOD 3: Self-Leveling Underlayment, Mapei

TCNA Rating: Extra Heavy

METHOD 4: Uncoupling Membrane, Blanke

TCNA Rating: Light Commercial

METHOD 5: Uncoupling Membrane, Mapei

TCNA Rating: Light Commercial

METHOD 6: Uncoupling Membrane 1, Schluter

Schluter approved assembly

METHOD 7: Uncoupling Mat, RedGard

Custom Building Products approved assembly

METHOD 8: NXT Level

Laticrete approved assembly

METHOD 9: Strata_Mat

Laticrete approved assembly

Ensure your chosen products and methods meet the standards set by the TCNA, ANSI and ICC. Follow the manufacturer's recommendations when using their products.

Warmboard Inc. is not an agent for manufacturers listed herein, and gives no implied warranty for any of these products or manufacturers on these assemblies.

BACKER BOARD

Backer board has a low mass and is relatively inexpensive to install. It can be 1/4" or 1/2" thick and provide a base for tiled areas which will match up well with adjacent finish flooring. There are a variety of Cementitious Backer Units (CBUs) available.

PROCESS

1. Clean the panels thoroughly.
2. Apply thinset to the surface of Warmboard using a square-notched trowel (this layer will function as a butter coating).
3. Immediately, before the thinset dries, fasten the backer board using backer board screws.
4. Use backer board tape on all seams.
5. Apply the thinset.
6. Finish with tile or stone.

Surface temperatures of the finish flooring should not exceed 85°F.

This specific assembly was TCNA tested. Substituting comparable brands is acceptable.

Backer board **must** run perpendicular to the Warmboard panels. Stagger the seams and take special care to avoid tubing damage when fastening.

- 1 Warmboard panel
- 2 Flexbond®
Custom Building Products
- 3 Wonderboard® Lite
Custom Building Products
- 4 Flexbond®
Custom Building Products
- 5 Tile or stone flooring

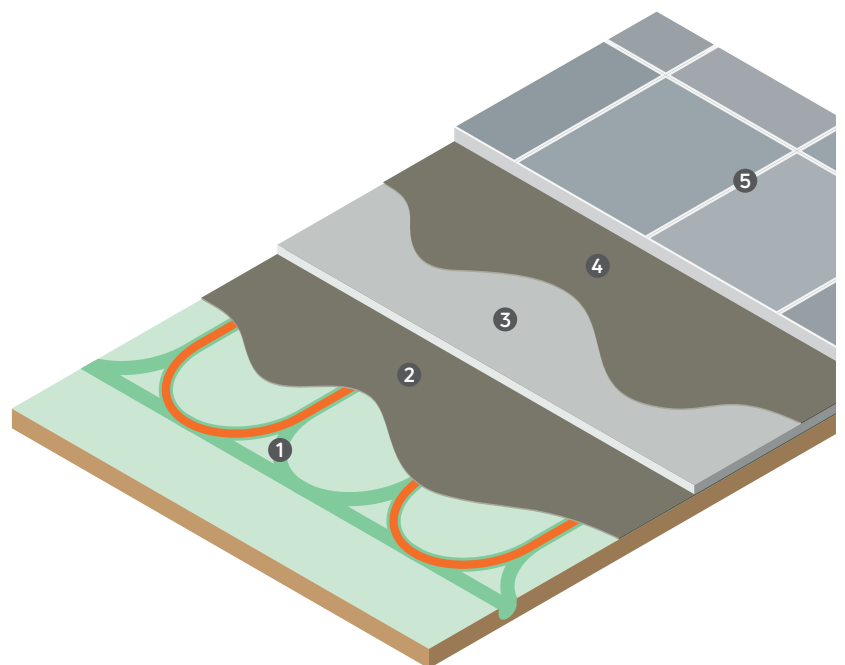

BACKER BOARD STENCIL

By placing a clear polyethylene sheet (3- or 4-mil) over a Warmboard panel, you can use a permanent marker to quickly create a stencil of the tubing pattern. Use this stencil as a guide over the backer board when installing the fasteners to avoid tubing damage.

PROCESS

1. Cut the polyethylene to the size of the backer board (cut all stencils at once to save time). **Do not** cut directly over the Warmboard or the tubing.
2. Place the sheets over the Warmboard panel and tape down the corners. Label the top and bottom of the stencil with a permanent marker, then trace the tubing pattern.
3. Remove the stencil and place it on the backer board.
4. Align the stencil over the backer board and mark fastener locations on the board through the stencil.
5. Trowel a coat of thin-set over the Warmboard panel.
6. Set the backer board in place.
7. Using the markings, fasten the board to the subfloor as normal.

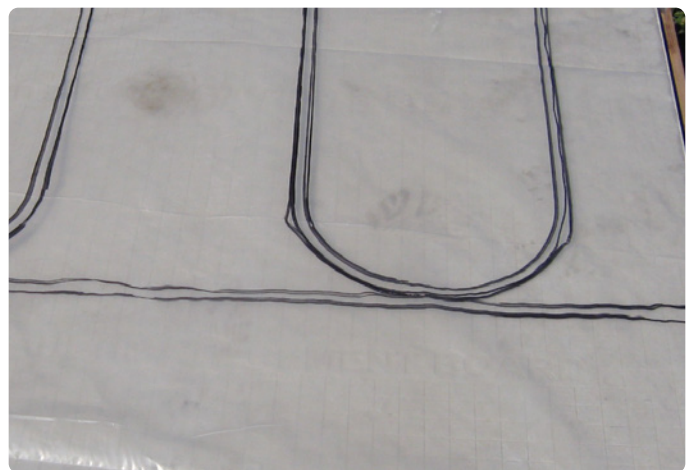

MUD BED, MAPEI

A mortar bed is the traditional method of addressing the expansion, contraction, and deflection properties of wooden subfloors while providing a continuous, thick, and stable surface for tile adhesion. However, they are expensive and add significant mass to a system. The thickness often causes the elevation of tile areas to misalign with adjacent carpeted or hardwood areas.

This specific assembly was TCNA tested. Substituting comparable brands is acceptable.

PROCESS

1. Clean the panels thoroughly.
2. Install a layer of 4- or 6-mil polyethylene to serve as a cleavage membrane.
3. Fasten the diamond wire mesh lath over the membrane using crown staples.
4. Finish with a minimum 3/4" mortar bed (Mapei® 4-to-1 Mud Bed Mix or equivalent).
5. After the mortar bed has cured, apply thinset.
6. Finish with tile or stone.

- 1 Warmboard panel
- 2 4-mil Polyethylene sheeting
- 3 Diamond wire mesh lath
- 4 4-to-1™ Mud Bed Mix
Mapei
- 5 UltraFlex™ 2
Mapei
- 6 Tile or stone flooring

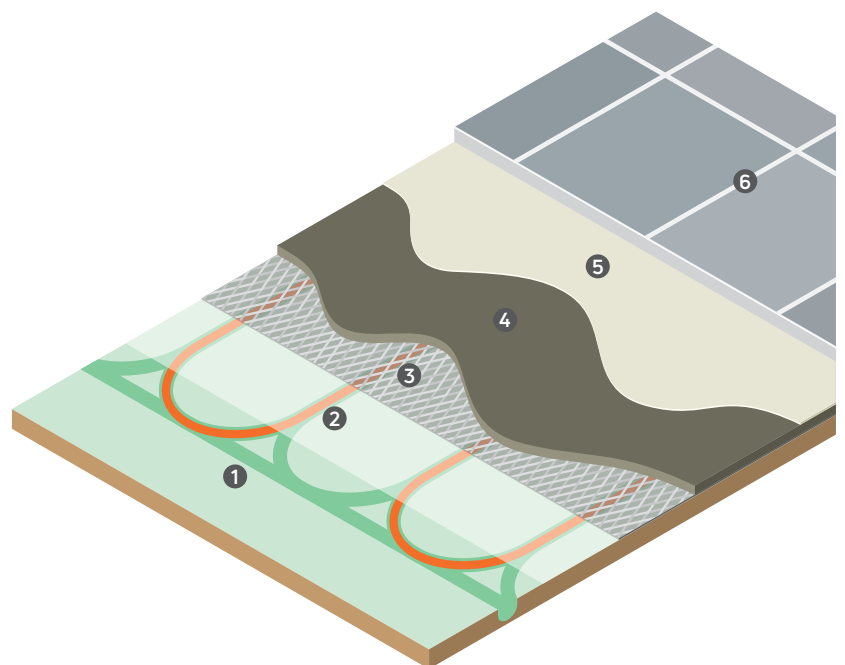

SELF-LEVELING UNDERLAYMENT, MAPEI

This product has a thin profile with the great strength of a mortar bed.

This specific assembly was TCNA tested. Substituting comparable brands is **not** recommended.

PROCESS

1. Clean the panels thoroughly.
2. Apply "Mapei Primer T" (per Mapei instructions).
3. Fasten the diamond wire mesh lath over the membrane using crown staples.
4. Mix and apply Ultraplan® Easy at a thickness of 3/8" or more.
5. Apply thinset.
6. Finish with tile or stone.

- ① Warmboard panel
- ② Diamond wire mesh lath
- ③ 3/8" Ultraplan Easy
Mapei
- ④ UltraFlex™ 2
Mapei
- ⑤ Tile or stone flooring

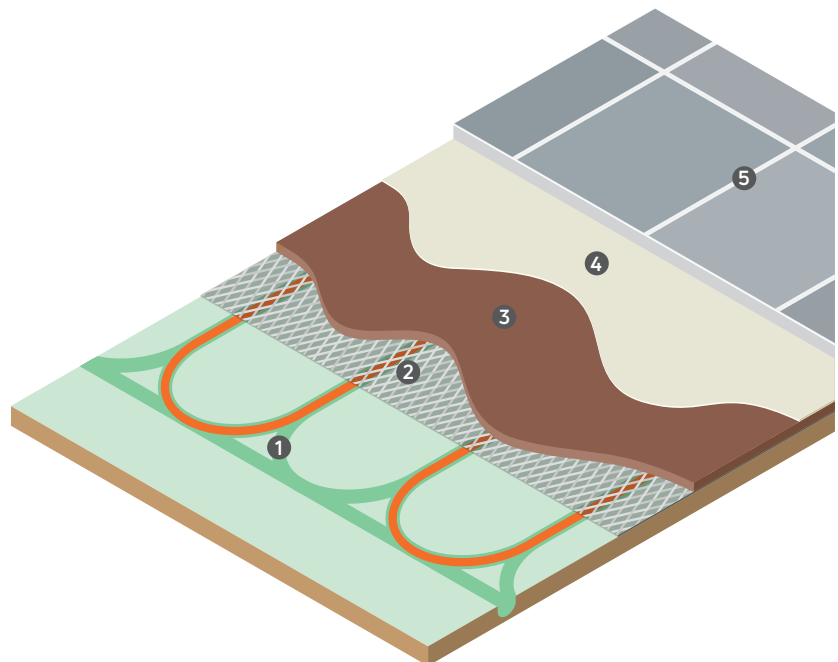

UNCOUPLING MEMBRANE, BLANKE

Blanke•PERMAT offers amazing crack isolation protection with superior compression and tensile strength. The Blanke•PERMAT reinforced mesh panel adds major support to wood subfloors, greatly reducing vertical subfloor movement (deflection).

This assembly was TCNA tested. Substituting comparable brands is **not** recommended.

PROCESS

1. Clean the panels thoroughly.
2. Trowel on the Mapei Granirapid thinset mortar using a V-notched trowel.
3. Immediately install the Permat.
4. The next day, follow with thinset using a square-notched trowel.
5. Finish with tile or stone.

- 1 Warmboard panel
- 2 Granirapid®
Mapei
- 3 Blanke • PERMAT
Blanke
- 4 UltraFlex™ 2
Mapei
- 5 Tile or stone flooring

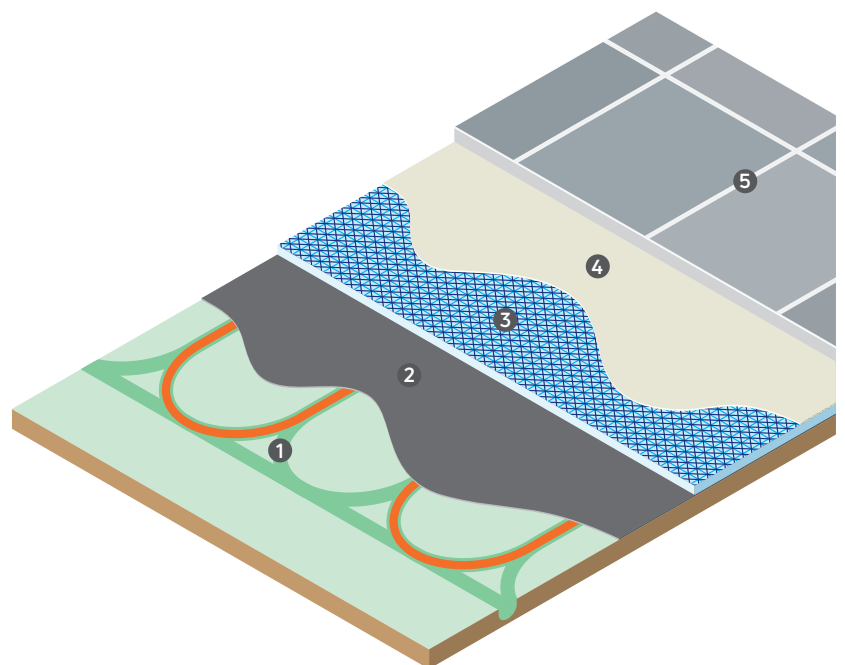

UNCOUPLING MEMBRANE, MAPEI

Mapeguard UM is a premium-performance, lightweight, waterproofing and vapor-pressure equalizing membrane that provides crack suppression for ceramic tile and stone installations.

Substituting comparable brands is **not** recommended.

PROCESS

1. Clean the panels thoroughly.
2. Apply the Mapei Granirapid® thinset mortar using a v-notched trowel.
3. Install the Mapeguard UM.
4. Wait for the mortar below the Mapeguard UM to be completely dry.
5. Trowel on the Kerabond/Keralastic System (or Ultraflex 3).
6. Immediately finish with tile or stone.

- 1 Warmboard panel
- 2 Granirapid®
Mapei
- 3 Mapeguard® UM
Mapei
- 4 Kerabond/Keralastic™ System
or Ultraflex™ 3
Mapei
- 5 Tile or stone flooring

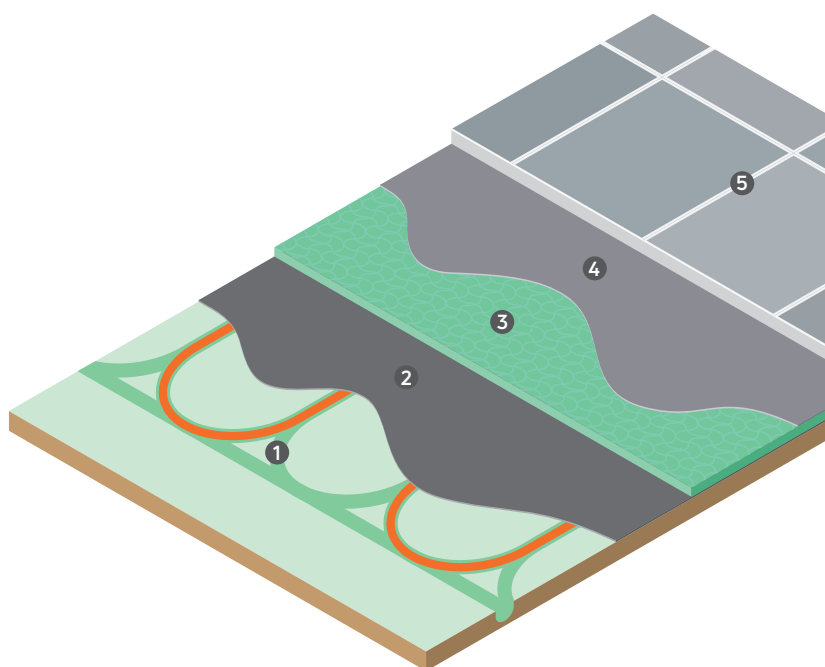

UNCOUPLING MEMBRANE, SCHLUTER®

Schluter®-DITRA® and DITRA-XL™ uncoupling membranes are designed to help prevent cracking in ceramic and stone tile installations. Made of waterproof polyethylene, these product installations can be waterproofed with minimal effort.

Substituting comparable brands is **not** recommended.

For stone applications over DITRA, structural joist (TJI) must be on 16" centers.

PROCESS

1. Clean the panels thoroughly.
2. Roll a layer of Schluter® PRIMER-U directly over Warmboard and PEX tubing.
3. Apply a layer of Schluter® ALL-SET®. Before the thinset is cured, install the uncoupling membrane.
4. Once the Schluter® ALL-SET® is completely dry, trowel Schluter® ALL-SET® modified thinset mortar directly on top of the uncoupling membrane.
5. Finish with stone or tile before the Schluter® ALL-SET® has cured.

- ① Warmboard panel
- ② Schluter®-Primer-U
- ③ Schluter ALL-SET®
- ④ Schluter®-DITRA™ or DITRA-XL™
- ⑤ Schluter ALL-SET®
- ⑥ Tile or stone flooring

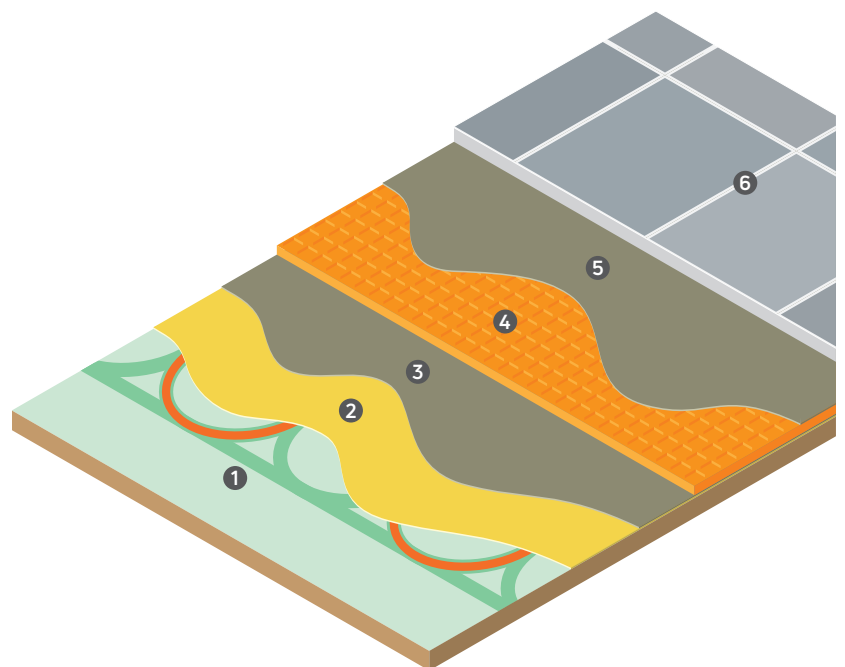

UNCOUPLING MAT, REDGARD

The RedGuard® Uncoupling Mat is a water and vapor-proof uncoupling membrane that can be used for crack-isolation in most tile, porcelain or natural stone installations. This product absorbs stress and preserves the surface and integrity of the tile. RedGuard Uncoupling Mat's bonding layers have reinforced fleece which locks mortar into the mat, ensuring strong, reliable installations.

Substituting comparable brands is **not** recommended.

PROCESS

1. Clean the panels thoroughly
2. Apply the Mapei Granirapid® thinset mortar using a v-notched trowel.
3. Immediately install the RedGuard Uncoupling Mat.
4. The next day, follow with thinset using a square-notched trowel.
5. Finish with tile or stone.

- 1 Warmboard panel
- 2 Granirapid®
Mapei
- 3 RedGuard® Uncoupling Mat
Custom Building Products
- 4 UltraFlex™ 2
Mapei
- 5 Tile or stone flooring

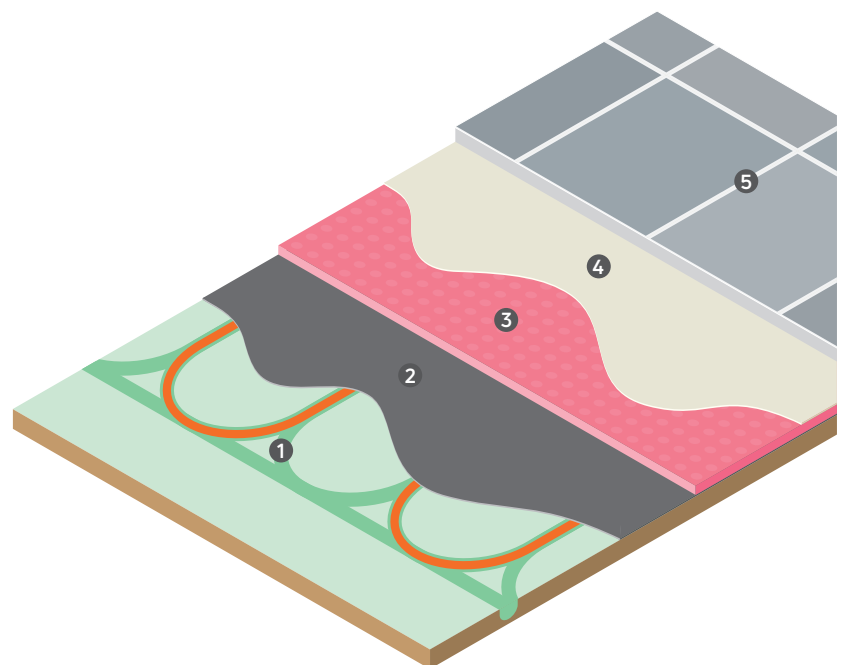

NXT® LEVEL, LATICRETE

NXT® Level is a cement-based underlayment for use in leveling interior substrates. NXT Level produces a flat, smooth and hard surface for the installation of finished flooring. NXT Level can be placed from 1/8" to 3" in a single lift.

Substituting comparable brands is **not** recommended.

PROCESS

1. Clean the panels thoroughly.
2. Apply a layer of Prime-N-Bond primer following manufacturer's specifications.
3. Install the diamond wire mesh lath and staple in place.
4. Once the primer has dried for 3-5 hours, apply any of the NXT Level underlayments in accordance to the manufacturer's specifications.
5. Apply Platinum 254 thinset.
6. Finish with tile or stone flooring.

- ① Warmboard panel
- ② Prime-N-Bond™
- ③ Diamond wire mesh lath
- ④ NXT® Level
- ⑤ Platinum 254
- ⑥ Tile or stone flooring

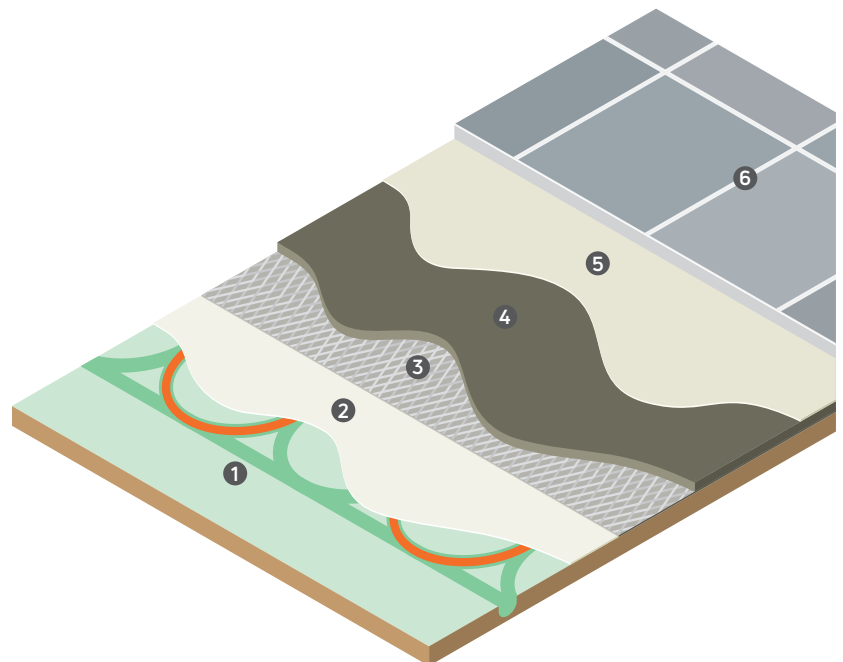

STRATA_MAT™, LATICRETE

STRATA_MAT™ uncoupling membrane is a high performance floor underlayment for use in tile and stone installations across residential and commercial applications. Designed to replace traditional underlayment materials, STRATA_MAT provides for an enhanced mechanical bond of thin-set adhesive with a faster dry time.

Substituting comparable brands is **not** recommended.

PROCESS

1. Clean the panels thoroughly.
2. Apply a layer of Prime-N-Bond primer following manufacturer's specifications.
3. Once the primer has dried for 3-5 hours, apply Platinum 254 thinset.
4. Immediately install the STRATA_MAT.
5. Apply Platinum 254 thinset.
6. Finish with tile or stone flooring.

- ① Warmboard panel
- ② Prime-N-Bond™
- ③ Platinum 254
- ④ STRATA_MAT
- ⑤ Platinum 254
- ⑥ Tile or stone flooring

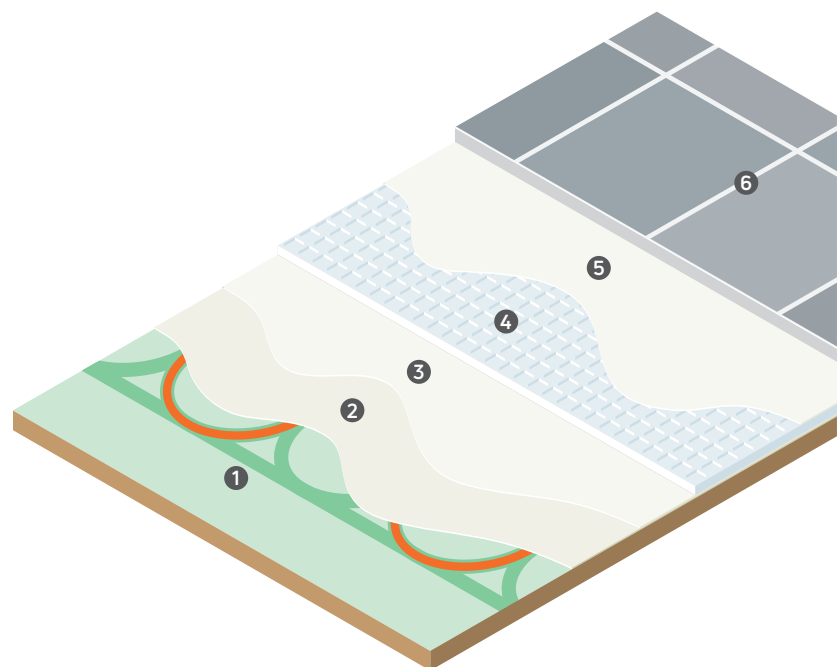

CARPET

Carpet and padding (cushion) installed directly over Warmboard is very common. We recommend an assembly with a low R-value (2.0-2.5) so that heat transfer is not negatively affected.

The R-values listed below are approximations based on carpet thickness. Check with the manufacturer to obtain accurate values.

While many brands of carpet padding are available in the marketplace, we **do not** recommend Prime Urethane, Bonded Urethane or Sunburst products due to their high R-values.

PROCESS

- Before installing the padding, fill all of the empty tubing grooves with a floor leveling compound or portland cement to make the grooves flush and level with the panel surface. Scrap pieces of PEX is also a good solution, though they should be fastened into place to prevent movement.
- **Do not** install padding and carpet until all the loops have been properly pressure tested.

R-value	Product
0.80	Arcadia
0.70	Aurora, Laguna, Coronado
0.60	Solano
0.71-0.80	Luxury Step
0.61-0.70	Full House, Tred-MOR 3700, Opulence, Horizon 100, Cloud 9, Luxury Walk
0.51-0.60	Berber Supreme, Horizon 80, Royal Flex, Pinnacle
0.41-0.50	Luxury Walk, Granite IV, Tred-MOR 2568, Tred-MOR 2580
0.31-0.40	Eclipse, Tred-MOR 2500, Contract Master, Onyx Super
0.21-0.30	Tred-MOR 1562, Onyx, Badger

Product	Thickness	R-value
Slab Foam Rubber	1/4"	R-0.31
	3/8"	R-0.47
	1/2"	R-0.62
Waffle Rubber	1/4"	R-0.62
	3/8"	R-1.00
	1/2"	R-1.33
Fiber/Hair/ Jute	1/4"	R-0.97
	3/8"	R-1.62
	1/2"	R-2.15

Carpet thickness	Est. R-value
1/8"	+/- 0.6
1/4"	+/- 1.0
1/2"	+/- 1.4
3/4"	+/- 1.8
1"	+/- 2.2

CORK

Cork flooring naturally has a high insulation value. By choosing a product that is 1/4" to 1/2" thick, the R-value will remain low (1.5 or less) and the heat output and response times of Warmboard will improve. It will also simplify your mechanical design, allowing the cork floor to operate at the same water temperatures as tile, hardwood or carpet.

STANDARD CORK

The installation of an underlayment is required over the Warmboard surface before standard cork flooring is installed. We encourage a 3/4" thick finish floor assembly, but priority should be given to matching floor heights throughout the house. Take care when fastening the underlayment to Warmboard because the tubing is obscured during this step. We recommend installing a 1/4" APA listed plywood underlayment with a sanded face. For complete installation details, refer to the "Engineered Wood Construction Guide" at apawood.org. Complete the installation of the cork by following all the manufacturer guidelines and specifications.

Once the underlayment is installed, the cork is adhered using a urethane adhesive made for cork applications. Consider Dri Tac 7500 (dritac.com).

Established brands include:

- ▶ Expanko Cork expanko.com
- ▶ American Cork amcork.com
- ▶ Natural Cork naturalcork.com

CORK LAMINATE

Cork laminate products contain a layer of MDF sandwiched between two layers of cork. Any barrier between the cork flooring and the Warmboard prior to installation is unnecessary.

This flooring installs the same as a floating floor and requires no adhesive or nailing for proper installation, providing flexibility for the homeowner if they ever decide to change the floor covering.

Follow all installation instructions provided by the finish flooring manufacturer.

When using a plywood or OSB (or equivalent) underlayment, you must fully acclimate before installation. If the moisture content of the underlayment is too high, it will shrink from the floor heating and cause an installation failure.

Do not use adhesive with plywood or OSB, only staples or screws.

Surface temperatures of the finish flooring should not exceed 85°F.

Failure to follow these guidelines will void any product warranty.



VINYL AND LINOLEUM

There are many types of vinyl flooring and all can be used with Warmboard.

Increasingly popular is the use of Luxury Vinyl Flooring (LVF) over Warmboard. This product emulates the look of natural materials like wood or stone, is very durable and could be a great option for areas expecting a lot of wear and tear.

We recommend using a substrate underlayment between the Warmboard and the vinyl or linoleum finish floor.

SUGGESTED UNDERLAYMENTS

- ▶ 1/4" or 1/2" interior plywood or OSB
- ▶ 1/4" or 1/2" tile backerboard (bathrooms, kitchens)
- ▶ Glue down sound control underlayment

We encourage a 3/4" thick finish floor assembly, but priority should be given to matching floor heights throughout the house.

The "Backer Board" and "Backer Board Stencil" pages in this guide can be helpful when installing this flooring to help avoid tubing damage.

Follow all installation instructions provided by the finish flooring manufacturer.

GenieMat RST is a good choice for sound control above Warmboard.



When using a plywood or OSB (or equivalent) underlayment, you must fully acclimate before installation. If the moisture content of the underlayment is too high, it will shrink from the floor heating and cause an installation failure.

Do not use adhesive with plywood or OSB, only staples or screws.

Surface temperatures of the finish flooring should not exceed 85°F.

Failure to follow these guidelines will void any product warranty.

COMMISSIONING



CONTENT GUIDE

- ▶ Manifold controller Page 68
- ▶ Thermostats Page 69
- ▶ System test Page 70
- ▶ Final checks Page 71

MANIFOLD CONTROLLER

PREPARATION

Before installing the controllers, be sure to turn off Construction Mode at the display on the SRC. This will turn off the pumps and boiler until the controls call for heat.

An installer **must** review the electrical page of your WCS Plan Set and note locations of all electrical components.

TUBING AND LABELING

Included with your controls is a series of labels to adhere to each supply and return loop beneath the manifold. Appropriate use of these labels will ensure each loop is accurately labeled for diagnostic issues. These color-coded labels coincide with the color labels on the side of the manifold controller (MC) and those displayed in your WCS Plan Set.

INSTALLING THE MC

1. Use the provided screws to mount each manifold controller (MC) inside the manifold location specified in the WCS Plan Set.
2. Plug the MC into the 120 volt outlet.

INSTALLING THE ACTUATORS

1. Thread the mounting rings from each actuator onto the shoulders of the valves on the manifold.
2. Attach actuators to each port on the return manifold.
3. Connect each actuator wire to the appropriate port on the side of the MC, which is pre-labeled and color coded. Refer to the WCS Plan Set as needed.

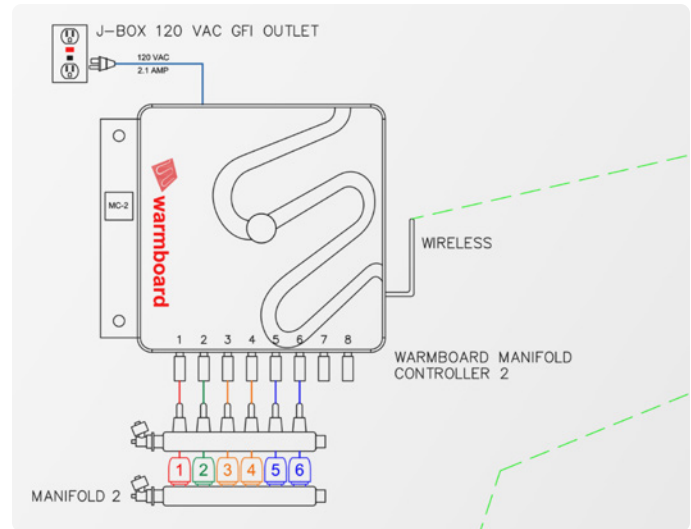

For the system to run in normal operation, you **must** disable Construction Mode through the display on the SRC.

THERMOSTATS

Warmboard Comfort System offers two different types of thermostats:

Heating

Controls the heat in one zone.

Heating/Floor Warming

Controls the heat in one bathroom and offers a warming feature which keeps the floor warm even when there is no call for heat.

THERMOSTAT INSTALLATION

Each thermostat **must** be installed in the location specified in the WCS Plan Set. Failure to do so will cause the system to perform erratically. If there are any discrepancies regarding the thermostat or zoning, contact us immediately.

1. Remove the appropriate thermostat from the box.
2. Grip the thermostat on the sides with one hand, and the back of the thermostat with the other hand, then slowly separate the pieces.
3. Set the face aside.
4. Connect the Line and Neutral (black and white) wires from the back plate (power supply) to the connections in the junction box, then fasten into place with the provided screws – be sure the arrows point up.
5. Snap the face of the thermostat back into place.

Repeat for each thermostat, always reference the Equipment and Piping Layout in the WCS Plan Set to check for thermostat locations.

After texture and paint, each thermostat **must** be installed in the correct location in order for the system to perform properly.

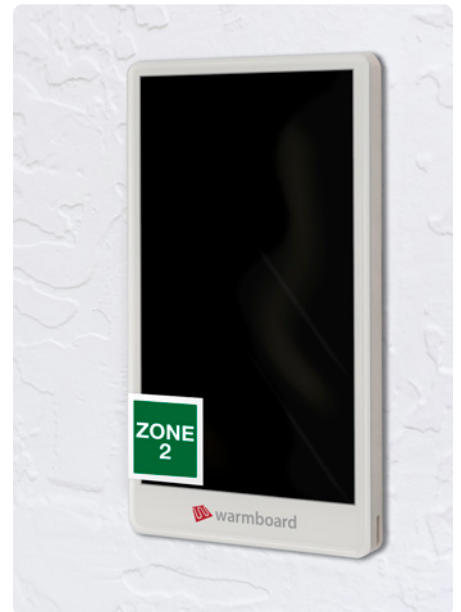

SYSTEM START-UP

PRIOR STEPS

It is imperative that all previous tasks have been completed before testing or operating the system.

- Use of Construction Mode to test the boiler and adjust flow rates on each loop.
- Disable Construction Mode from the SRC display.
- If Warmsource has operated in Construction Mode near any dust or debris, service and clean the heat exchanger prior to normal operation.
- Successful installation of all electrical components (manifold controllers, actuators, thermostats).

Once these steps have been completed sequentially, reset the Warmsource power and proceed to the next steps.

SRC DISPLAY

While it is not required to use the SRC interface for system start-up, the following menu items may be useful in confirming system setup and connectivity.

- **Status:** Check boiler set points, water temperatures, error codes, and valve states across the entire system.
- **System:** Confirm device count and check firmware versions on all equipment in the system.
- **Network:** Confirm the network configuration and test signal reliability of the LoRa and Wi-Fi networks.
- **Setpoints:** Adjust important water and room temperature settings for the system. **Note:** this may impact the overall performance of the system.

Menu



Turbo Mode Water Temp: This is the temperature of the water supplied to the system when a zone is 5°F degrees from set point or when a zone is slow to heat.

Boiler Max Water Temp: This is the maximum water temperature that will be called in normal heating operation outside of Turbo Mode.

When Warmboard thermostats are set to **Off**, they will maintain a minimum temperature of 55°F by default.

TESTING THE CONTROLS

With all components installed, it's time to test each zone independently to ensure the thermostats are accurately controlling each zone.

1. To begin, go to the zone 1 thermostat, then follow the instructions below.
2. Tap the thermostat screen.
3. Next, tap the **Menu icon**  in the upper right corner and to enter the main menu. Click the **Information icon** to familiarize yourself with the menu.
4. Once complete, go to **Settings**, then **System Tests** and tap **Test Zone**.
5. Go to the manifold cabinet for this zone. On the manifold controller you will see a red light on the loops requesting a call for heat.
6. After 5 minutes, the red lights will turn green, indicating that the actuators have opened and water is flowing to the zone.
7. If something does not appear to be working properly, consult your WCS Plan Set.
8. After 15 minutes, the test will end.
9. Repeat this process for each thermostat and tap **Test Zone**.
10. Go to the manifold cabinet for this zone. On the manifold controller you will see a red light on the loops requesting a call for heat.
11. After 5 minutes, the red lights will turn green, indicating that the actuators have opened and water is flowing to the zone.
12. If something does not appear to be working properly, consult your WCS Plan Set.
13. After 15 minutes, the test will end.

Repeat this process for each thermostat.

TESTING COMMUNICATION

Before testing the zones independently, verify that the system components are communicating. To do this, complete the following steps in the SRC:

1. In the **Network** menu, tap **Signal Reliability**.
2. On the next screen select **LoRa Test**.
3. Reference the test results and check on any of the pieces of equipment which are not communicating.
4. Check for power to the units.
5. Check that antennas are completely attached.

WI-FI CONNECTIONS

Wi-Fi connectivity is an important feature as it allows the user to access their system through our mobile application and allows the system to receive important software updates.

1. Perform the LoRa communication test from the SRC, which is described on the previous page.
2. Note which thermostat has the best communication with the SRC and proceed to that thermostat's location.
3. Tap the thermostat screen, then tap the  icon.
4. Choose **Settings**, then **Connectivity**.
5. Follow the prompts to connect to the local Wi-Fi.
6. Return to the SRC to verify that the Wi-Fi Network on the **Network** page matches the local Wi-Fi Network.

If network connectivity issues arise while commissioning, resetting the power to the thermostats, MCs and SRC is an ideal way to reinitialize the system's communication. This can be done using Diagnostic Mode on the SRC.

WATER TEMPERATURE CHART

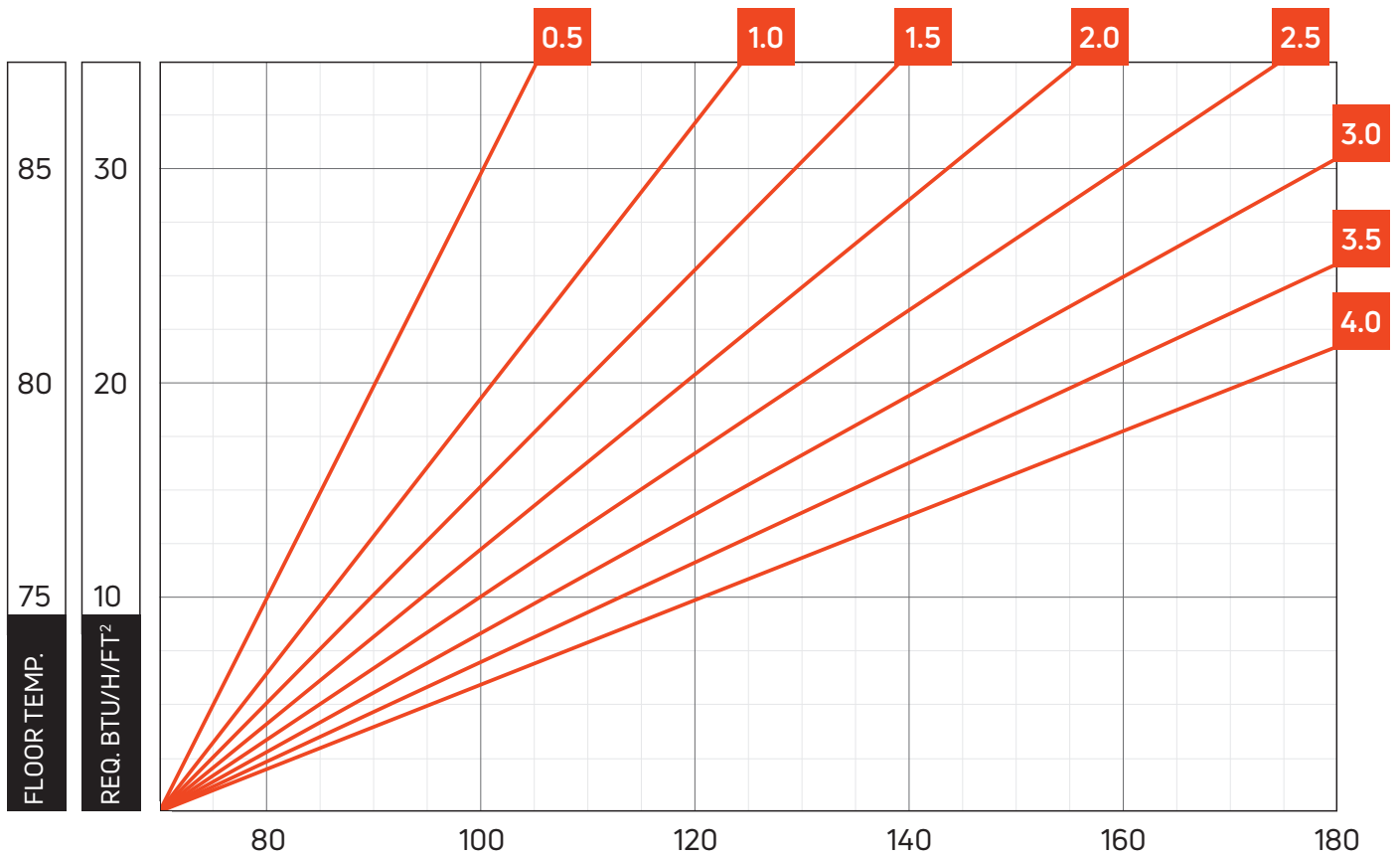

Average of Supply/Return Water Temperature at Manifold for Good Dynamic Performance

This chart assumes an ambient air temperature of 70°F

■ = R-value (thermal resistance)

Steady State performance requires 10% lower water supply temperature.
Assumes minimum R-19 insulation below the floor.

NOTICE: Customer is solely responsible for determining whether the products and the information contained in this installation guide are appropriate for Customer's use and are in compliance with applicable laws because the applicable laws related to the installation and use of this product may vary from one location to another and may change with time. Customer represents and warrants that Customer is required to check current local laws, building codes and other local requirements and that all local requirements will be adhered to in connection with the installation of this product.

NO EXPRESS WARRANTIES ARE GIVEN EXCEPT FOR ANY APPLICABLE WRITTEN WARRANTIES SPECIFICALLY PROVIDED BY WARMBOARD. ALL IMPLIED WARRANTIES INCLUDING THOSE OF MERCHANTABILITY AND FITNESS FOR A PARTICULAR PURPOSE ARE EXPRESSLY EXCLUDED. FAILURE TO INSTALL WARMBOARD PRODUCTS ACCORDING TO MANUFACTURER'S INSTRUCTIONS WILL VOID ALL APPLICABLE WARRANTIES. IT IS EXPRESSLY UNDERSTOOD THAT WARMBOARD IS NOT RESPONSIBLE FOR ANY CONSEQUENTIAL OR OTHER DAMAGES THAT MAY ARISE FROM USING WARMBOARD PRODUCTS OR COMPONENTS.

Warmboard assumes no obligation or liability for the information contained in this document. The Customer assumes all risks as to the use of this product. Customer's exclusive remedy or any claim (including any claim for negligence, strict liability, or tort, without limitation) shall be limited to the warranty coverage expressly provided in Warmboard's warranty documents. Failure to stringently adhere to any of the recommended procedures of this installation guide and/or any other Warmboard document related to this product shall release Warmboard of all liability with respect to this product or the use thereof.

For complete warranty information call 1.800.556.0595 or visit warmboard.com

KEEP OUT OF REACH OF CHILDREN



warmboard.com // 800.556.0595